

USER GUIDE



HD TERMINAL
MULTI-ROOM HD PVR
ILLICO 4K ULTRA HD



TABLE OF CONTENTS

Activation	3
Your Terminal	4
Installation	8
Remote Control	10
Programming Your Remote Control	11
Equipment Settings	12
Maintenance Plan	13
Frequently Asked Questions	14
Customer Service and Technical Support	16
Security	17
Signal Theft	19
Notes	20

GIVE YOUR OLD TERMINAL THE SECOND CHANCE IT DESERVES—RECYCLE IT!

Recycle out-dated electronic devices like cellphones, digital terminals, modems, routers and accessories. Simply drop them off at any Videotron or Videotron le superclub store. It's easy—do your good deed today.

videotron.com/werecycle



For more information, visit us at videotron.com/terminal-support

CONGRATS ON YOUR NEW VIDEOTRON ILLICO TERMINAL!

You now have exclusive access to illico Cloud, your gateway to the best TV entertainment experience out there.

With illico Cloud:

- Watch live TV and pick up where you left off watching, anywhere you go.
- Customize your TV experience as you build your user profile. illico Cloud remembers you and keeps track of what you like to watch, as well as your favourites.
- Record the shows you love remotely.
- Enjoy sharp picture quality and store memorable TV moments.
- Use the Multi-Room PVR to watch recordings on any TV in your home.
- Take advantage of high-tech features that make your life easier. There's one menu for everything, a streamlined and user-friendly Program Guide, smart Video on Demand service and a search tool that quickly scans the entire illico catalogue for you.

Use your tablet or mobile device to download the free illico app now for unrivalled multiscreen entertainment!



Watching TV has never been so simple! illico offers you the best of both worlds: you get to choose between pay-per-view access or an unlimited viewing experience.

- Tune in to channel **900** for a wide selection of special releases, new arrivals, series, events, documentaries and on-demand programming that you can order on a pay-per-view basis.
- Sign up for Club illico and get unlimited access to Videotron's catalogue of movies, series, kids shows and documentaries. Watch as many times as you want!

For more information, visit us at videotron.com/terminal-support

YOUR TERMINAL

ILLICO 4K ULTRA HD TECHNICOLOR 10455HD

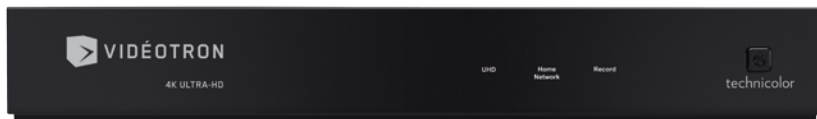

BACK OF THE TERMINAL



- | | | | |
|---|------------------------------------|---|-----------------|
| 1 | Coaxial audio/video input | 5 | Unusable ports |
| 2 | Unusable ports | 6 | HDMI 2.0 output |
| 3 | Composite and audio output | 7 | Power input |
| 4 | SPDIF optical digital audio output | | |

NOTE: Pictures for reference purposes only

For more information, visit us at videotron.com/terminal-support

SAMSUNG VD940CJ ILLICO 4K ULTRA HD **HDMI**



BACK OF THE TERMINAL

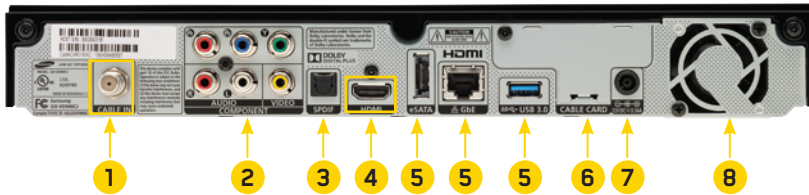

- | | | | |
|---|--|---|-----------------|
| 1 | Coaxial AV cable | 5 | Unusable port |
| 2 | Analogue component, composite and audio output | 6 | CableCard input |
| 3 | SPDIF optical digital audio output | 7 | Power input |
| 4 | HDMI 2.0 output | 8 | Fan |

NOTE: Pictures for reference purposes only

For more information, visit us at videotron.com/terminal-support

SAMSUNG 6340 HD TERMINAL



SAMSUNG 8340 HD PVR



BACK OF THE TERMINAL

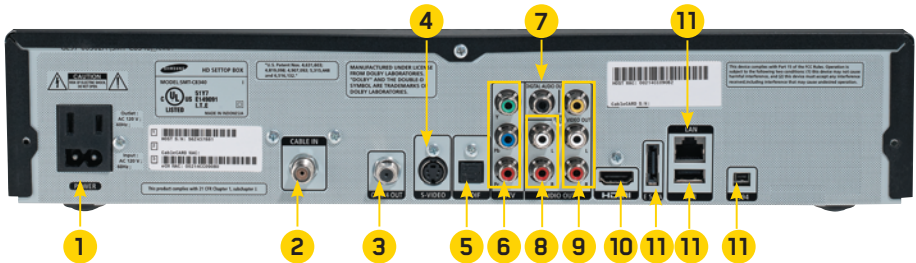

- | | |
|------------------------------|--------------------------------|
| 1 Power supply | 7 Digital coaxial audio output |
| 2 Coaxial audio/video input | 8 RCA audio output |
| 3 Coaxial audio/video output | 9 RCA audio/video output |
| 4 S-Video output | 10 HDMI audio/video output |
| 5 Optical audio output | 11 Unusable port |
| 6 Component video output | |

NOTE: Pictures for reference purposes only

For more information, visit us at videotron.com/terminal-support

CISCO 4642 HD TERMINAL



CISCO 8642 HD PVR



BACK OF THE TERMINAL



- | | | | |
|---|------------------------------|----|----------------------------|
| 1 | Coaxial audio/video input | 7 | S-Video output |
| 2 | RCA audio/video output | 8 | Coaxial audio/video output |
| 3 | Component video output | 9 | HDMI audio/video output |
| 4 | RCA audio output | 10 | Unusable port |
| 5 | Digital coaxial audio output | 11 | Power supply |
| 6 | Optical audio output | | |

NOTE: Pictures for reference purposes only

For more information, visit us at videotron.com/terminal-support

INSTALLATION

ACTIVATION

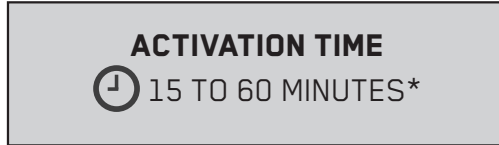

If you received your Terminal via Canada Post, please follow these steps:

1. Connect your Terminal by referring to the Connection section.
2. Turn on the Terminal. Activation should start automatically and may take up to 60 minutes.

If you bought your Terminal from one of our authorized dealers (rather than in a Videotron store), please follow these steps:

1. Connect your Terminal by referring to the Connection section.
2. Once your Terminal is connected, wait 60 minutes before calling the telephone number below for activation. Toll-free number: 1-877-226-6385

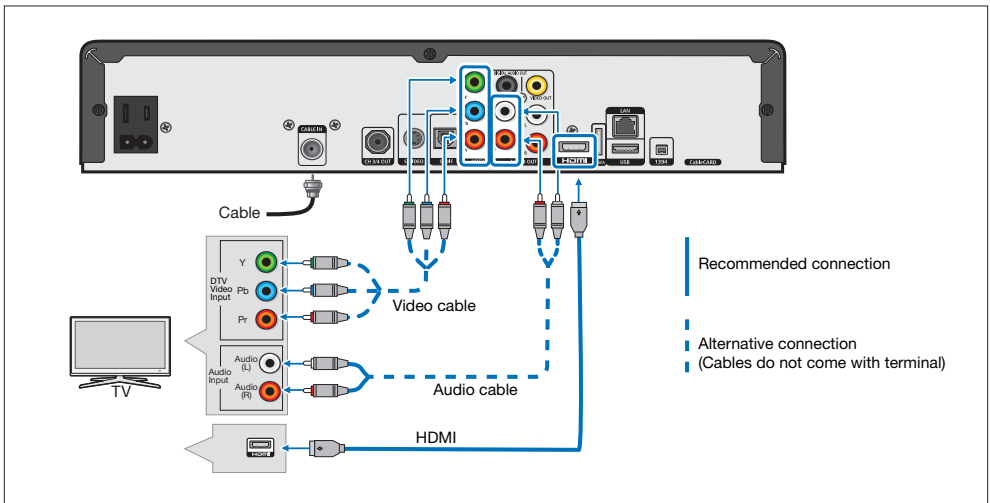





For more information, visit us at videotron.com/terminal-support

CONNECTION

We recommend using the HDMI cable provided, which can transfer both the video and audio signal from your Terminal to your TV in high definition.

NOTE:

- If your TV does not have an available HDMI outlet, use an alternative outlet (see diagram).
- For all other connections (via a sound system, for example), consult our website: videotron.com/soutien.

1. Plug one end of the HDMI cable (included in the box) into your TV. 
2. Connect the other end of the HDMI cable to your new terminal. 
3. Connect the coaxial cable to your terminal. 
4. Plug the terminal power cable into an outlet. 
5. Select the HDMI source on your TV that corresponds to your new terminal.
6. The welcome screen will take 15 to 60 minutes to appear.*



During the activation of your terminal, some information will be displayed on your TV screen and different codes will show up on your terminal (e.g.: OCAP, APP). Your screen might also remain blank for some time. **Do not worry, you don't need to do anything!**

7. When the welcome screen appears, your terminal is ready.



*Average activation time. The initialization period differs depending on the terminal.

For more information, visit us at videotron.com/terminal-support

REMOTE CONTROL



LEGEND:

PVR: HD PVR

VOD: Video on Demand

For more information, visit us at videotron.com/terminal-support

PROGRAMMING YOUR REMOTE CONTROL





To get the most out of your new Terminal, we recommend that you read the next few pages to ensure that you properly program your remote to your TV.

There are two ways to program your remote control:

1. **Quick programming for your TV or audio system**
2. **Programming by the brand of your tv**
(this method is detailed on our website at videotron.com/terminal-support)



QUICK PROGRAMMING

NOTE: When you program the remote control to an audio system, it will only allow you to adjust the volume on the audio system, not the volume on the TV.

1. Turn on your TV and/or your sound system. First program your TV and then your sound system.
2. Press the  and  buttons simultaneously until the red light under the  button blinks twice, then release both buttons.
3. Press **9-9-1** on the remote control. The red light will blink twice.
4. Then press **1** to search for a TV code, or press **3** to search for a sound system code.
5. Point the remote control at the TV or the sound system. Repeatedly press and release the **CH+** button until the device turns off.
6. When the device is off, press the  button to confirm the programming. The red light will blink twice. If the programming didn't work, repeat steps 2 to 5.
7. Repeat steps 2 to 5 to program your audio system

RESETTING YOUR REMOTE CONTROL

If you would like to program your remote control to work with other devices, or if you are having problems getting it to work, you can reset it by following these steps:

1. Press the  and  buttons simultaneously until the red light under  blinks twice, then release both buttons.
2. Press **9-7-7** on your remote control. The red light will blink four times to confirm that the remote control has been reset.

For more information, visit us at videotron.com/terminal-support

EQUIPMENT SETTINGS

This section will help you configure your video and audio preferences so that you can get the most out of your HD TV and new Terminal.

Go to your Terminal's preferences:

1. Press **MENU** to launch the main menu.
2. Using the arrows, go to **Settings and Applications** in **My illico**.
3. Select **Settings**, go to **Equipment Settings** and then press **OK**.

You can choose:

- **When you would like your Terminal to switch to standby mode:** Configure your Terminal so that it turns off automatically when you want it to (date and time).
- **When you would like your Terminal to turn on:** Configure your Terminal so that it turns on automatically when you want it to (date and time).
- **The model of your remote control:** Select the model of your remote control to get the most out of its features.
- **The picture resolution:** For optimal picture resolution, it's important to set your TV to the right aspect ratio:
 - SD = 480i or 480p
 - HD = 1080i or 720p
 - For Ultra HD, your TV's auto resolution function will automatically select UHD/4K resolution for you.

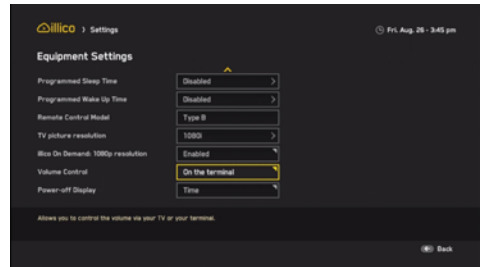
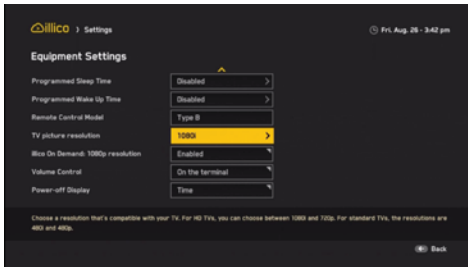

- **The volume control:** Determine whether you would like your remote to control the volume on your TV or Terminal. If your remote control has been programmed to your TV, please ensure that the volume control button is set to work with your TV or audio system.
- **The display:** Display the time on the Terminal when it is turned off.

For more information, visit us at videotron.com/terminal-support

VIDEOTRON'S STANDARD WARRANTY

Benefit from a free, three-year (3) standard warranty on your Terminal.¹ In the event of breakage resulting from normal use of the original Terminal, the standard warranty entitles you to a free replacement Terminal of equal or superior quality.²

This warranty automatically begins on the activation date of the new Terminal and offers the following advantages:

- Automatic replacement of a defective device with a new device within a three-year (3) period²
- No waiting: One of our technicians will replace the defective Terminal free of charge

GET TOTAL PEACE OF MIND WITH VIDEOTRON'S MAINTENANCE PLAN²

Videotron gives you the opportunity to improve and extend your Terminal's standard warranty for an extra two (2) years. You can subscribe to the Maintenance Plan within 30 days of your service activation date.

As such, the Terminal you purchased, as well as the remote control, will be covered for a period of **five (5) years** after the service activation date. If your Terminal or remote control is defective, the warranty under the Maintenance Plan entitles you to exchange it for a new piece of equipment.³

GET PEACE OF MIND

	One-Time Payment	Monthly Payments (for 36 months)
HD Terminal ¹	\$49.99⁵	\$1.99⁵
HD PVR ¹	\$99.99⁵	\$3.99⁵
illico 4K Ultra HD ¹	\$99.99⁵	\$3.99⁵

1. Cisco 4642, Samsung 6340 HD Terminal, Cisco 8642, Samsung 8340 HD PVR, Samsung VD940CJ or Technicolor 10455HD. 2. This applies to customers who have purchased a new device. A defective terminal will be replaced with a refurbished terminal, or a new terminal where available, of equal or superior quality. 3. This warranty is non-transferable except in special cases. The Maintenance Plan is not offered with the purchase of a refurbished terminal. 4. The replacement terminal or remote control will be of equal or superior quality to the one that was defective. 5. Taxes extra.

For more information, visit us at videotron.com/terminal-support

FREQUENTLY ASKED QUESTIONS

NOTICE: The first step in resolving problems related to the illico TV service is to reboot the Terminal. Rest assured—your Terminal settings, as well as the recordings on your Multi-Room HD PVR, will remain intact. To reboot the Terminal, unplug the power supply cord, then plug it back in again a few seconds later. Wait a few minutes before turning the Terminal back on. If the problem persists, please contact Technical Support at 1-877-380-2611.

Where can I learn more about the Program Guide, menus and illico apps?

Videotron has provided you with a **Help Menu** that you can access via illico TV's main menu and videotron.com/support. There, you'll find demos, answers to frequently asked questions and a comprehensive user guide that you can download. You can also access the **Help Menu** through illico's main menu when you press the  button on your remote control and select **What's New** in **My illico** section.

Can I program my remote control to my TV?

Yes. To do so, follow the steps outlined on page 11.

I can't control the Terminal's volume with the remote control. Is this normal?

In order to provide you with the highest level of sound quality, the volume controls on the Terminal are disabled when the latter is connected with an HDMI cable. If this is the case, you will only be able to control the volume on your TV. You will have to program your remote control to your TV by following the instructions on page 11.

I programmed my remote control, and now the sound isn't working. What should I do?

You may have activated the Terminal's "Mute" function while programming the remote control by pressing OK/SELECT and MUTE. If this is the case, press the VOL+ button on your Terminal. This will disable the "Mute" function, and bring the sound back.

Why is the sound on my TV so low?

Your Terminal's volume function controls the strength of the audio signal emitted by the Terminal. When the Terminal's volume is low, the signal it sends to the TV is equally low. To prevent this, we suggest that you program your remote control to your TV by following the instructions on page 11, and then program the Terminal so that you can only control the volume on your TV. To do this, please refer to the **Equipment Settings** section on page 12.

My Terminal is not working, or my TV screen is black, blue, blurry or snowy. What should I do?

Make sure the Terminal is turned on and that you followed the steps for activating and connecting (on page 8) the Terminal. Because your TV has multiple inputs, it's important to let your TV know the one you're using. Set your TV to the right input using the remote control it came with (i.e. by setting it to either Input 1, 2 or 3; Component 1, 2 or 3; or HDMI 1, 2 or 3).

For more information, visit us at videotron.com/terminal-support

The sound cuts or the picture breaks up when I watch TV. What should I do?

Reboot the Terminal by unplugging the power supply cord and plugging it back in. If the problem persists, restart the Terminal as indicated above, or contact Technical Support at 1-877-380-2611.

When I plug in my Terminal with an HDMI cable, the picture breaks or an error message appears on screen. What should I do?

Once you've made sure that the HDMI cable is properly plugged into the Terminal, reboot the Terminal by unplugging the power supply cord and plugging it back in. If the problem persists, it may be that your TV is not compatible with the Terminal's HDMI port. Instead, proceed with the alternative connection by using a component cable. Seeing as the Terminal does not come with a component cable, please contact your retailer or call Technical Support at 1-877-380-2611.

Is it normal that broadcasts on certain channels don't fill the screen?

Yes. The only channels that broadcast full-screen are HD channels (channels after channel 600). Channels where the picture does not fill the screen are standard definition channels. However, some shows airing on HD channels are broadcast in standard definition.

How can I switch to full screen mode when I'm watching a channel that's broadcast in standard definition?

The # button on your remote control allows you to stretch the picture or to zoom in and get rid of the black bars that border the left and right of the screen when you're watching a channel in standard definition. Press # until you obtain the desired zoom mode: Normal, Large or Zoom.

After activating my Terminal, is it normal that I can access channels that are not included in my TV package?

Yes. Once you have activated your Terminal, you'll be able to access the channels included in your TV package on the business day following the activation date. As a result, you'll have free, temporary access to several channels that aren't necessarily part of your TV package.

I have an illico 4K Ultra HD PVR but I'm unable to watch Ultra HD content.

To fully enjoy the Ultra HD experience, customers must have the following: an Ultra HD TV, an illico 4K Ultra HD Terminal (with an HDMI 2.0 cable connecting it to the TV) and 4K content.

CUSTOMER SERVICE AND TECHNICAL SUPPORT

CUSTOMER SERVICE

For further information, we invite you to visit the illico TV Help Portal, or check out instructional videos at videotron.com/terminal-support or contact Customer Service. You can reach a representative at 1-888-433-6876, Monday-Friday from 7:30 a.m. to 10 p.m., and Saturdays and Sundays from 8 a.m. to 8 p.m.

TECHNICAL SUPPORT

For problems of a technical nature, we invite you to contact Technical Support at 1-877-380-2611. You can reach a representative 24 hours a day, 7 days a week.

THE COMPLETE USER GUIDE IS AVAILABLE AT
videotron.com/terminal-support

For more information, visit us at videotron.com/terminal-support

For security purposes, please read the following before connecting your Terminal.

POSITIONING AND VENTILATION

The Terminal has openings for ventilation that protect it from overheating.

- Avoid obstructing these openings and do not place other equipment, including televisions, lamps, books or any other objects, on the Terminal. Do not place it in an enclosure such as a bookcase or equipment rack, unless suitable ventilation is provided.
- Do not place the Terminal on a bed, sofa, rug or similar surface, or close to a radiator or source of heat.
- Lay the Terminal on a stable surface that's able to support its size and weight.

ACCESSORIES AND CLEANING

Only use Videotron-recommended accessories. Do not open the cover of the Terminal. Unplug the Terminal and clean it with a damp cloth. Do not use a liquid or aerosol cleaner, or a magnetic/static cleaning device.

OBJECT AND LIQUID ENTRY

Do not expose the Terminal to moisture, or spill liquid on or near it. Do not place the Terminal on a wet surface. Never push objects of any kind into the Terminal's openings, as they may touch dangerous voltage points or cause short-circuits that could result in a fire or electric shock.

POWER SOURCES

A label on the Terminal indicates the correct power source for this equipment. Operate the Terminal only from an electrical outlet that has the voltage and frequency indicated on the label. Do not overload electrical outlets or extension cords, as this could result in a fire or electric shock.

POWER CORD PROTECTION

To avoid damaging them, arrange all power cords so that they are not walked on and make sure no objects are placed on or against them. Pay particular attention to cords that are connected to plugs, electrical outlets or accessories, and to the places where the cords exit the Terminal.

Caution! To prevent electric shock, match wide blade of plug to wide slot, then insert fully. If you are unable to fully insert the plug into the outlet, contact an electrician to replace your obsolete outlet.

GROUNDING

The Terminal has a two-prong plug. Properly ground the unit by inserting the plug into a grounded electrical, two-socket outlet. If the plug is polarized, it has one wide prong and one narrow prong. This plug fits only one way.

SERVICING

This unit is covered by a three-year warranty. Opening the case will void your warranty. Refer all servicing to a qualified Videotron technician. Contact your cable service provider for instructions. Service should be referred to a Videotron technician when any of the following occurs:

- There is damage to the power cord or plug.
- Liquid enters the unit, or there is exposure to rain or water.
- A heavy object falls on the unit, or you drop the unit or damage the casing.
- The unit malfunctions (the instructions in this guide describe the proper operation).
- The unit shows a distinct change in performance.

EXTENDED WARRANTY

For greater peace of mind, Videotron offers you the possibility of extending the warranty for an additional two years. Customers who want this extended warranty must apply for it within 30 days of the service activation date. The unit purchased will then be covered for a total of five years following the activation date.

For more information, visit us at videotron.com/terminal-support

IMPORTANT: We wish to remind you that you are responsible for notifying Videotron of your new address and telephone number if you are moving. All the HD terminals you get for your home must be connected to the network at the same address.

Videotron's network can detect a terminal that has been relocated and reconnected to the network. In certain circumstances, the terminal will be deactivated. In some cases, legal proceedings may be initiated for signal theft.

SIGNAL THEFT IS ILLEGAL.

Theft is theft. Stealing radio and television signals is no different. The law is clear: On April 26, 2002, the Supreme Court of Canada upheld a law making the theft of broadcasting signals illegal in Canada. A message brought to you by the Coalition Against Signal Theft, which wants you to know the facts. The Coalition includes satellite distributors, cable companies, broadcasters, producers, programmers and artists.

