

USER GUIDE



HD TERMINAL
MULTI-ROOM HD PVR



CONTENTS

Set-Up	3
Activation.....	4
Overview of Your Terminal.....	5
Connect Your Terminal.....	7
Your Remote Control.....	11
Program Your Remote Control.....	12
Equipment Settings.....	16
Help Portal.....	16
How to Use illico TV new generation	17
Main Menu and Shortcut Menu.....	17
Interactive Program Guide.....	18
Modify and Customize Displayed Channels.....	19
How to Create and View a List of your Favourite Channels.....	19
Search.....	20
Widgets.....	21
3D.....	21
illico On-Demand	22
How to Rent a Movie or TV Show.....	23
Parental Controls.....	24
Resume Viewing Content.....	24
Pay-Per-View (PPV) Services	26
Multi-Room HD PVR	28
Main Menu.....	28
Live TV Control.....	30
Record a TV Program.....	31
Managing Your Recordings.....	33
Managing Your Hard Disk.....	35
Settings	36
General Settings.....	36
Controls and Limits.....	37
Application Preferences.....	39
Accessibility.....	41
FAQ	42
Customer Service and Technical Support	44
List of Remote Control Programming Codes	45
Security	49

For further information, visit videotron.com/terminal-support.

SET-UP

CONGRATULATIONS ON YOUR PURCHASE OF THIS HD TERMINAL OR MULTI-ROOM HD PVR, YOUR GATEWAY TO THE ILLICO TV NEW GENERATION EXPERIENCE.

With illico TV new generation:

- Enjoy a new, customized TV experience that's faster, more powerful and easier to use
- Get a faster, user-friendly browsing tool
- Manage your recordings easily with the Multi-Room HD PVR
- Gain access to a personalized interactive 15-day Program Guide
- Use handy apps like the Miniguide and a variety of widgets (i.e. weather forecasts, lottery results, illico news, etc.)
- Fully immerse yourself in the HD experience thanks to exceptional image quality and menus adapted to HD TVs
- Watch your recordings on any TV in your home, thanks to the Multi-Room PVR.

Entertainment that gives you:

- Exclusive access to illico On-Demand, which offers thousands of movies and shows, 4,000 of which you can watch for free
- Access to Club illico: available with your monthly subscription. Club Unlimited gives you access to a vast catalogue of on-demand movies, series, kids' shows and documentaries, on channel 900 and on your computer or iPad via illico.tv.

A multi-screen experience means:

- You can watch your favourite shows live or on-demand on your computer or tablet via illico.tv, or on your Videotron mobile phone via illico Mobile.

For further information, visit videotron.com/terminal-support.

ACTIVATION

If you received your terminal via Canada Post, please follow these steps:

1. Connect your terminal by referring to the **Connect Your Terminal** section.
2. Once your terminal is plugged in, dial the number below to activate it.
Toll-free: 1-877-226-6385.
Monday to Friday: 7:30 a.m. to 10 p.m. | Saturday and Sunday: 8 a.m. to 8 p.m.
3. Follow steps 3 to 5 below.

If you bought your HD terminal or Multi-Room HD PVR from one of our authorized dealers (rather than in a Videotron store), please follow these steps:

1. Connect your terminal by referring to the **Connect Your Terminal** section.
2. Turn on the terminal. Activation should start automatically and may take up to 10 minutes.
 - If activation fails, dial 514-380-7834 or 1-866-380-2134.
Monday to Friday: 7:30 a.m. to 10 p.m. | Saturday and Sunday: 8 a.m. to 8 p.m.
3. We strongly recommend that you follow the Quick-Start Wizard that will automatically pop up when you turn on your terminal for the first time.
The Quick-Start Wizard shows you how to:
 - i. Set the display language of your terminal.
 - ii. Activate the Administrator PIN to manage certain functions of the terminal and order on-demand content. Administrator PIN: _____
 - iii. Activate and configure Parental Controls.
4. Create an Order PIN for access to content permitted by Parental Controls
Order PIN: _____
5. Program your remote control to your TV by following the instructions on page 12.



WARNING: If you see the “WIZ 502” error message on your screen, please contact Technical Support (see page 45) immediately as it means that certain applications will not work.

For further information, visit videotron.com/terminal-support.

OVERVIEW OF YOUR TERMINAL

SAMSUNG 6340 HD TERMINAL



SAMSUNG 8340 MULTI-ROOM HD PVR



BACK OF THE TERMINAL*

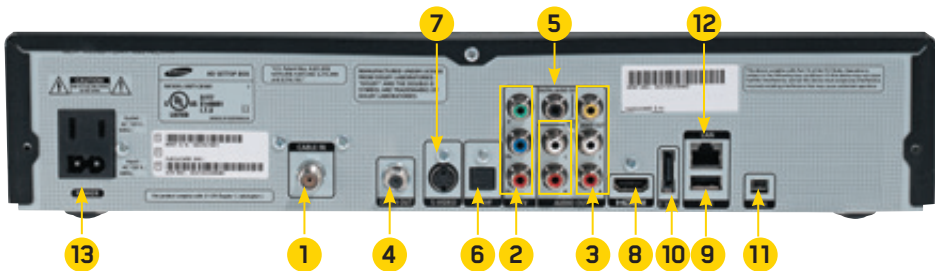

- | | | | |
|---|------------------------------|----|---|
| 1 | Coaxial audio/video input | 8 | HDMI audio/video output |
| 2 | Component video output | 9 | USB port (currently unavailable) |
| 3 | RCA audio/video output | 10 | eSATA port
(only available on the Multi-Room HD PVR) |
| 4 | Coaxial audio/video output | 11 | FireWire port (currently unavailable) |
| 5 | Digital coaxial audio output | 12 | Ethernet port (currently unavailable) |
| 6 | Optical audio output | 13 | Power supply |
| 7 | S-video output | | |

***NOTE:** Photo for illustration purposes only

For further information, visit videotron.com/terminal-support.

CISCO 4642 HD TERMINAL



CISCO 8642 MULTI-ROOM HD PVR



BACK OF THE TERMINAL*



- | | | | |
|---|------------------------------|----|---|
| 1 | Coaxial audio/video input | 8 | Coaxial audio/video output |
| 2 | Component video output | 9 | HDMI audio/video output |
| 3 | RCA audio/video output | 10 | USB port (currently unavailable) |
| 4 | RCA audio output | 11 | eSATA port
(only available on the Multi-Room HD PVR) |
| 5 | Digital coaxial audio output | 12 | FireWire port (currently unavailable) |
| 6 | Optical audio output | 13 | Ethernet port (currently unavailable) |
| 7 | S-video output | 14 | Power supply |







*NOTE: Photo for illustration purposes only

For further information, visit videotron.com/terminal-support.

CONNECT YOUR TERMINAL

The terminal can be connected in various ways. To get the most out of your terminal, please connect it in the way recommended for your system. To watch a demo of how to connect your terminal, visit support.videotron.com/residential.

MOST FREQUENTLY USED VIDEO AND AUDIO CABLES

	HDMI cable – An HDMI cable transmits high-definition (up to 1080p) video to your TV , as well as Dolby 5.1™ audio, with just one cable. We recommend an HDMI cable.
	Component cable – The component video cable (red, blue, green) transmits 1080i high-definition video to your TV.
	RCA component and stereo cables – The yellow component or RCA cable transmits standard-definition video, where as the red and white cable transmits stereo sound.
	S-video cable – The S-video cable transmits standard-definition video (standard-definition TV only).
	Coaxial digital audio cable – The coaxial digital audio cable transports Dolby 5.1™ digital sound to a home theatre system.
	Optical audio cable – The optical audio cable transports Dolby 5.1™ digital sound to a home theatre system.

For further information, visit videotron.com/terminal-support.

CONNECT YOUR HD TERMINAL OR MULTI-ROOM HD PVR TO AN HD TV

illico TV new generation is suited to widescreen HD TVs with a 16:9 aspect ratio. The instructions listed below apply to HD TVs only. If you have a standard TV or if your TV requires alternative measures, please contact your retailer or call Technical Support at 1-877-380-2611.

RECOMMENDED CONNECTION PROCEDURE

HDMI – The HDMI cable transmits high-definition digital video and audio to your TV, with a resolution of up to 1080i.

1. Plug in your terminal using the recommended cable, as shown below.

If your TV does not support an HDMI connection, use an alternative connection.

2. Turn on the terminal by pressing  on your remote control.

3. Turn on your TV and select the corresponding **Audio/Video** input (input 1/2/3 or component 1/2/3) to display content on-screen.

4. Complete the Quick-Start Wizard that automatically appears when your terminal is turned on for the first time.

5. Program your remote control to your TV by following the instructions on page 12. This will, among other things, enable you to control the volume on your TV with the remote control for the terminal.

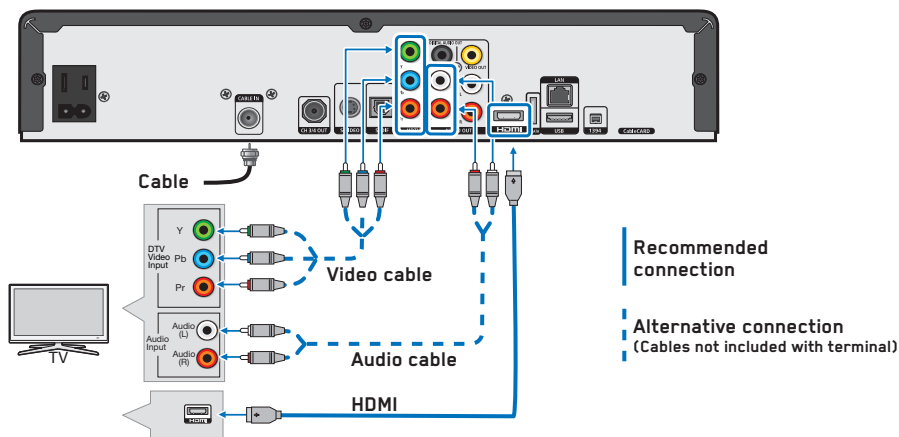

IMPORTANT:

1. If your screen is blank or starts blinking, please restart your terminal by unplugging the power cord and plugging it back in.
2. If the problem persists, or if the WIZ 502 error message pops up, please contact Technical Support at 1-877-380-2611.
3. For other types of connections, please see your retailer.
4. Should the self-installation fail, a fee may apply if a technician is required to come to your home.

For further information, visit videotron.com/terminal-support.

HD TERMINAL OR MULTI-ROOM HD PVR WITH STANDARD TV

illico TV new generation is suited to widescreen HD TVs with a 16:9 aspect ratio. If you connect your terminal to the component cable, S-Video or a standard TV, the image and interface quality may be affected. Therefore, even though such connections are possible, they are not recommended.

POSSIBLE CONNECTION

Go with this configuration if you use red and white RCA cables for audio and yellow for video. If you don't have an RCA connector, you can substitute it with a green component cable. Despite the difference in colour, it will still transmit video signal just like a yellow component cable. You can get such cables at your local Videotron store or from our Technical Support service.

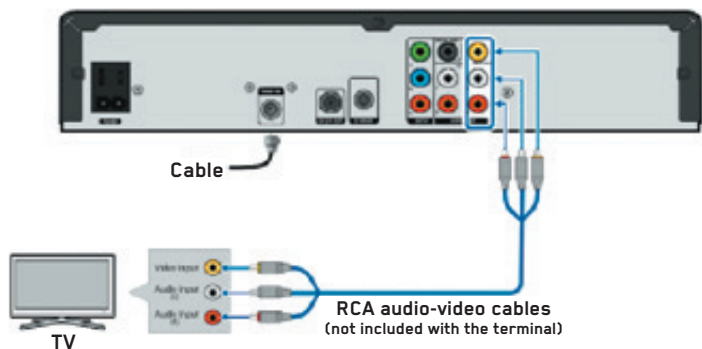

1. Connect your equipment by following the diagram above.
2. Turn on the terminal by pressing  on your remote control.
3. Turn on your TV and select the corresponding **AUDIO/VIDEO** input (Input 1/2/3) to display content on-screen.
4. Complete the Quick-Start Wizard that automatically appears when your terminal is turned on for the first time. Program your remote control to your TV by following the instructions on page 12.

WARNING: If you see the "WIZ 502" error message on your screen, please contact Technical Support (see page 44) immediately as it means that certain applications will not work.

Should the self-installation fail, a fee may apply if a technician is required to come to your home.

For further information, visit videotron.com/terminal-support.

HD TERMINAL AND MULTI-ROOM HD PVR WITH HOME THEATRE SYSTEM

RECOMMENDED CONNECTION PROCEDURE

Use this configuration if you are connecting your terminal to a 5.1 home theatre system.

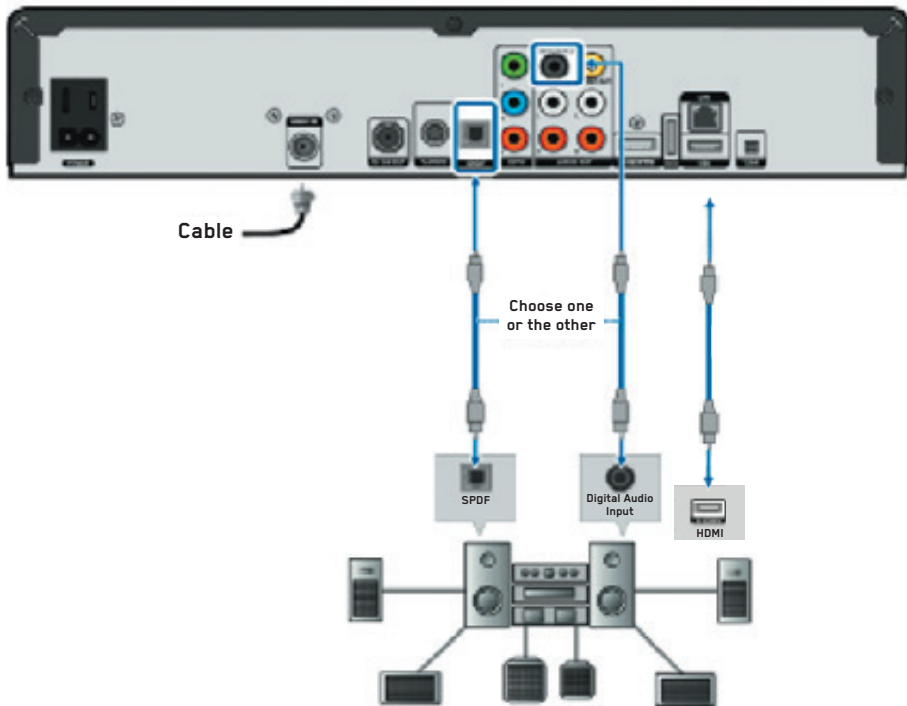

1. Refer to the diagram above and choose a connection type.
 - i. If you're connecting your terminal to the audio system with an HDMI cable, your audio system must also be linked to your TV through the HDMI input.
 - ii. If you're connecting your terminal to the audio system with an optical audio cable or coaxial digital cable, please refer to the previous pages for the video connection.
2. Turn on the terminal by pressing  on your remote control.
3. Program your remote control to your TV by following the instructions on page 12.
4. Turn on your sound system and select the corresponding audio input.

NOTE: For further information on connecting your audio system, please refer to your home theatre user guide.

WARNING: If you see the "WIZ 502" error message on your screen, please contact Technical Support (see page 44) immediately as it means that certain applications will not work.

Should the self-installation fail, a fee may apply if a technician is required to come to your home.

For further information, visit videotron.com/terminal-support.

YOUR REMOTE CONTROL



LEGEND:

PVR: Multi-Room HD PVR

IOD: illico On-Demand

For further information, visit videotron.com/terminal-support.

PROGRAM YOUR REMOTE CONTROL







To get the most out of your new terminal, we recommend that you read the next few pages to ensure that you properly program your remote to your TV.

There are three ways to program your remote control:

1. **Quick programming: for your TV only.**
2. **Programming using automatic search: for your TV or audio system.**
3. **Programming by code: for your TV or audio system.**

QUICK PROGRAMMING OF YOUR REMOTE CONTROL

If your TV brand is not among the 10 brands listed below, please use the Automatic Search Programming Method described on the next page.

1. Turn on your TV.
2. Hold down  and  at the same time until the red light under  blinks twice, then release both buttons.
3. Press  once. The red light will stay lit.
4. Point the remote control at the TV. Refer to the table below and enter the number corresponding to the brand of your TV (e.g. 2 for LG). The red light will blink twice and the TV will turn off.
5. Press  to lock the code.
6. Turn your TV back on. If this programming procedure did not work, repeat steps 2 to 5 or use the Automatic Programming procedure described on the next page.
7. Once your remote control has been programmed, press  and select Settings.
8. Then select Equipment Settings and specify that the remote's volume adjustment keys control the volume on the TV (see Equipment Settings on page 16).

NUMBER	HD TV BRANDS
1	INSIGNIA
2	LG
3	MITSUBISHI
4	PANASONIC
5	PHILIPS/MAGNAVOX





NUMBER	HD TV BRANDS
6	SAMSUNG
7	SHARP
8	SONY
9	TOSHIBA
0	VIZIO

For further information, visit videotron.com/terminal-support.

PROGRAMMING YOUR REMOTE CONTROL USING THE AUTOMATIC SEARCH METHOD

If the Quick Programming procedure did not work, follow the instructions below. This remote control programming method allows you to control your TV and your audio system.

NOTE: When you have programmed the remote control to your audio system, you will no longer be able to adjust the volume on your TV, only on your audio system.

1. Turn on your TV and audio system. Program your TV first.
2. Hold down  and  at the same time until the red light under  blinks twice, then release both buttons.
3. Press **9-9-1** on the remote control. The button will flash twice.
4. Then press **1** if you are looking for a TV code or **3** if you are looking for an audio system code.
5. Point the remote control at your TV or audio system, then press and release the **CH+** button until the device that you are programming turns off. You may need to press **CH+** several times in order to make this happen.
6. When the device turns off, press  to lock the code. The red light will blink twice. If this programming procedure did not work, repeat steps 2 to 5.
7. To program your audio system, repeat steps 2 to 5.
8. Once your remote control has been programmed, press  and select **Settings**.







NOTE: If neither of the two suggested programming methods work, refer to the programming by code method.

For further information, visit videotron.com/terminal-support.

PROGRAMMING YOUR REMOTE CONTROL WITH A CODE

Follow the instructions below if you would like to program the remote control to your TV and audio system.

NOTE: When you have programmed the remote control to your audio system, you will no longer be able to adjust the volume on your TV, only on your audio system. However, this setting can be modified by following the instructions on page 15 (see the **Change How Your Remote Control Is Programmed** section).

1. Turn on your TV or audio system. Program your TV first.
2. Find the code corresponding to the brand of your device in the list at the end of this guide. The brands are listed in alphabetical order.
3. Hold down  and  at the same time until the red light under  blinks twice, then release both buttons.
4. Enter the first five-digit code on your device. If you have done it correctly, the  backlight will blink twice.
NOTE: If the button blinks once and remains lit for a long time, this means the code you have entered is invalid. Repeat steps 3 and 4 using the same code or another code, if possible.
5. Point the remote control at your device and press . The device should turn off. If nothing happens, repeat steps 2 to 5.
6. To program your audio device, repeat steps 2 to 5.
7. Once your remote control has been programmed, press  and select Settings.
8. Then select Equipment Settings and specify that the remote's volume adjustment keys control the volume on the TV (see Equipment Settings on page 16).

Your TV code: _____

Your audio system code: _____



For further information, visit videotron.com/terminal-support.

CHANGE HOW YOUR REMOTE CONTROL IS PROGRAMMED



Changing the volume button:

When you program your remote control to your TV and audio system, the volume button will work with the device that you programmed last. To control the volume via your TV or audio system, please refer to the following instructions.

To control the volume via your TV:



1. Hold down  and  at the same time until the red light under  blinks twice, then release both buttons.
2. Press **9-9-3**. The red light will blink twice.
3. Press 2.

To control the volume via your audio system:

1. Hold down  and  at the same time until the red light under  blinks twice, then release both buttons.
2. Press **9-9-3**. The red light will blink twice.
3. Press 3.

RESETTING YOUR REMOTE CONTROL

If you would like to reprogram your remote control to other devices or if you are having problems getting it to work, you can reset it by following these steps:

1. Hold down  and  at the same time until the red light under  blinks twice, then release both buttons.
2. Press **9-7-7** on your remote control. The red light will blink four times to confirm that the remote control has been reset.

EQUIPMENT SETTINGS

This section will help you to configure your video and audio preferences so that you can get the most out of your HD TV and new terminal.

Accessing your terminal preferences:

1. Press **MENU** to go to the main menu.
2. Using **⬅️**, select **Settings** then **Equipment Settings**, then press **OK SELECT**.

You can change:

- **When you would like your terminal to switch to standby mode:** Configure your terminal so that it turns off automatically when you want it to (date and time).
- **When you would like your terminal to turn on:** Configure your terminal so that it turns on automatically when you want it to (date and time).
- **The model of your remote control:** Select the model of your remote control to get the most out of its features.
- **The picture resolution:** It is important to choose a 1080i or 720p resolution, depending on the viewing mode of your HD TV. If you do not have an HD TV, you can choose a 480i or 480p resolution. HD channels are available after channel 600.

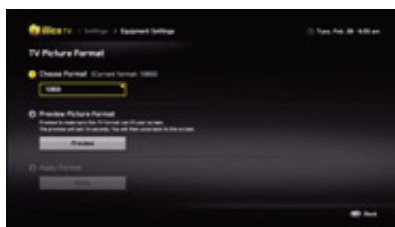
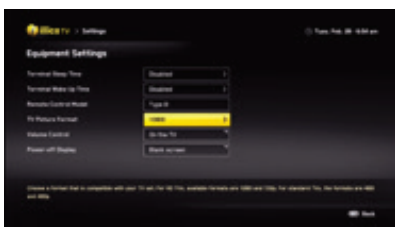

- **Volume control:** Determine whether you would like your remote to control the volume on your TV or terminal. If your remote control has been programmed to your TV, please ensure that the volume control button is set to work with your TV or audio system.
- **Display:** Display the time on the terminal when it is off.

HELP PORTAL

illico TV new generation now has a Help Portal in the main menu. The Help Portal offers demos and an FAQ section for most of the available features.

How to access the Help Portal:

- Press **MENU** to go to the main menu.
- Using **⬅️**, select **HELP** and press **OK SELECT**.
- Browse the menu using **⬅️**, select the topic that interests you and press **OK SELECT**.
- You will find an FAQ under each Help section. Some topics are explained with a video.

For further information, visit videotron.com/terminal-support.

HOW TO USE ILLICO TV NEW GENERATION

MAIN MENU AND SHORTCUT MENU

The main menu gives you access to all available illico TV new generation features, like the Program Guide, illico On-Demand, settings, the search function, widgets, and much more!

Main Menu

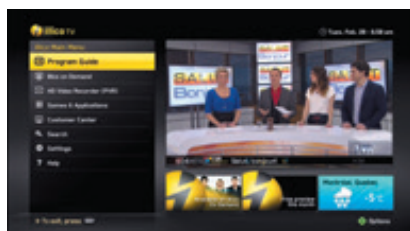

Shortcut Menu



ACCESS THE MENU

1. Press **MENU** to go to the main menu.
2. Browse the menu or the widgets using **UP**. When you browse illico TV menus, you can always press **LEFT** to return to the previous screen.
3. Press **OK SELECT** to confirm your choice.

ACTIVATE AND PERSONALIZE THE SHORTCUT MENU

illico TV new generation also offers a **Shortcut Menu** that lets you choose the shortcuts you want.

1. Press **MENU**.
2. Using **UP**, select **Settings**, then **Application Preferences**.
3. Using **UP**, select **Shortcut Menu**.
4. In the drop-down menu, select **Activate or Disable** the Shortcut Menu, then customize it by choosing the shortcuts you want.

NOTE: You can customize the **Shortcut Menu** from the main menu by pressing **DOWN**. Please note that the Program Guide and illico On-Demand cannot be removed from this menu.

For further information, visit videotron.com/terminal-support.

INTERACTIVE PROGRAM GUIDE

The Interactive Program Guide lists the shows that are being broadcasted at that time and those to come over the next 15 days.

Complete Guide



Full Screen Mode

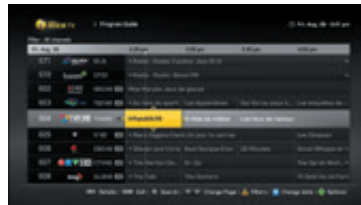

Miniguide



HOW TO USE THE PROGRAM GUIDE

1. Press **GUIDE** to display the complete Guide (press it again to see it in full-screen mode).
2. Use **LEFT** to browse the Program Guide.
3. Press **INFO** to get more information on the selected schedule.
4. Press **OK** to go to the selected channel.

NOTE: When the  icon is displayed to the left of the Program Guide, it means that you are not subscribed to this channel.

HOW TO USE THE MINIGUIDE

1. While you are watching content, press **INFO**.
2. Use **LEFT** to go from one channel to the next and from one schedule to another. Press **OK** to go to the selected channel.
3. If you hover the cursor over a show in the Miniguide, a description will automatically pop up. If this does not happen, press **INFO**.
4. Press **EXIT** to exit.

NOTE: You can modify the automatic display of information relating to a show in the Miniguide. Under **Settings** in the main menu, select **Application Preferences**.





For further information, visit videotron.com/terminal-support.

MODIFY AND CUSTOMIZE DISPLAYED CHANNELS





CHANNEL FILTER

You can filter the channels displayed in the Program Guide by using a wide range of criteria. You can display:

- All channels or only the ones that you are subscribed to;
- Your favourite channels or those that broadcast content in the language of your choice (French, English, or other);
- Channels by genre (i.e. sports, news, movies, family shows, etc).





1. Press .
2. Press , then select **Filter**.
3. Select the filter you want using  and press .
4. When a channel filter is activated, an icon will appear in the top left-hand corner of the Program Guide. The filter will remain active even when you close the Program Guide.
5. To remove the filter, you must select **Display All** or switch to a channel that is not included in the filter that you selected.

Browse through channels by name or by number:



1. Press .
2. Press  and select **Sort** using .
3. Select **By Name** or **By Number** and press .

HOW TO CREATE AND VIEW A LIST OF YOUR FAVOURITE CHANNELS

Adding or removing your favourite channels in the Program Guide or while watching TV:

1. In the Program Guide, use  to select a channel and press . A star on the left of the Program Guide will indicate your favourite channels.
2. You can browse through your favourite channels using the  button on your remote control or with the **Favourite Channels** browsing filter by selecting  in the Program Guide.
3. You can remove a channel from your Favourite Channels list by pressing  and selecting **Remove from Favourite Channels**.

Adding or removing several favourites at once:

1. Press  to go to the main menu.
2. Select **Settings**.
3. Then select **Application Preferences** and **Program Guide**.
4. Select **Favourite Channels** and press .
5. A window will pop up prompting you to select your favourite channels from the list of channels included in your TV package (menu on the left) or remove channels that you have already selected (menu on the right).

For further information, visit videotron.com/terminal-support.

SEARCH

illico TV new generation has an Advanced Search function that allows you to quickly find content in the Interactive Program Guide, illico On-Demand, Pay-Per-View TV service, and content recorded on your Multi-Room HD PVR.

How to use the Search function:

1. Press **Q** on your remote.
2. When the on-screen keyboard is displayed, use **OK** to enter the title or the name of the actor you are looking for. Relevant content will begin to be displayed from the second letter that you enter. The more letters you enter, the more accurate your search results will be.
3. For search results that are even more accurate, select **Display Filters** at the bottom of the keyboard.
4. Select the content for more information.



On-screen keyboard

Content displayed by category (celebrity, movie title, etc.)

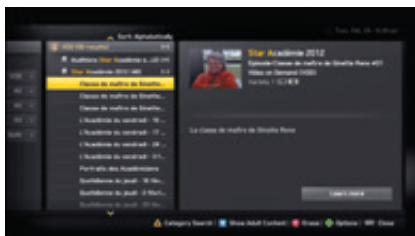





For further information, visit videotron.com/terminal-support.

WIDGETS

Widgets are handy mini-applications that offer quick access to information. For example, in the main menu, you will see a weather tile. This tile (or widget) offers you quick access to weather forecasts for your region.

How to access widgets:

1. Press  on your remote control or press  to display the main menu on-screen. You will see a list of widgets at the bottom of the screen. You can also select **Games and Applications** from the main menu. Select the widget you want using  and press .

HOW WIDGETS ARE DISPLAYED WHILE YOU WATCH TV



NOTE: To edit the settings of a widget (i.e. weather or lottery), go to your preferences and select the widget you want to edit.

3D

Videotron lets you view content in 3D.

Experience 3D on a 3D TV

It is possible to view all 3D content offered by Videotron on a 3D TV using the glasses provided by your TV's manufacturer. For questions relating to use, please refer to the User Guide that came with your TV.

Go to channel 800 for more details on 3D programming.

Tune in to channel 900 to view the list of on-demand 3D movies, or visit the Terminal Support section of our website for more information on this technology.

For further information, visit videotron.com/terminal-support.

ILICO ON-DEMAND

ILICO HOMEPAGE

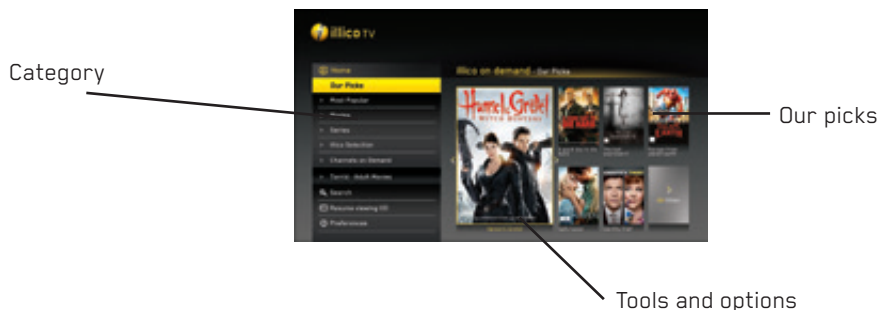









illico On-Demand is where you can watch movies, popular TV shows, comedy shows and much more, whenever you want, in the comfort of your home. This service gives you access to channel 900, illicoweb.tv and illico Mobile at any time. In fact, illico On-Demand offers the widest range of content (in French and in English), which you can access when you want. You'll find:

- A wide range of on-demand HD movies on channel 900
- Movie premieres, available the day they are released on DVD/Blu-Ray
- On-demand channels like The Movie Network, Disney Junior, Family, HBO, etc.
- Thousands of free titles





Club illico: Available with your monthly subscription, Club illico gives you access to a vast catalogue of over 1,000 titles, including movies, series and shows. For more information, go to illico.tv/clubillico.

Handy buttons for when you use illico On-Demand:

-  To access illico On-Demand
-  To resume viewing content you paused
-  To pause
-  To rewind; press up to four times to increase the rewind speed
-  To fast-forward; press up to four times to increase the fast-forwarding speed
-  To stop watching content
-  To skip back a chapter
-  To skip forward a chapter

For further information, visit videotron.com/terminal-support.

HOW TO RENT A MOVIE OR TV SHOW

1. Press **900** to go to illico On-Demand.
2. Browse through the menus using  and choose the category or the content that you'd like to see. Press **OK**  for each selection and press  to return to the previous screen.
3. When you have selected content, you can choose between the following three options: **Order**, **Watch the Trailer** or **Add to My Selection**. Then, press **OK** .

Automatic display



Information regarding content

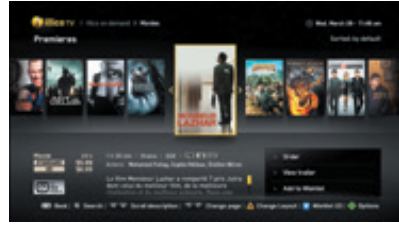

4. When you are ordering content, a window will pop up on-screen asking you to choose the language in which you would like to view the content (**FR/EN**) and the viewing mode (**HD** or **SD**). If an option is unavailable, it will be shaded. **You will need your PIN to confirm your order. If you did not create a PIN when you set up your terminal, a window will pop up prompting you to create an Administrator PIN.**
5. The ordered title will be available for the period indicated on-screen and can be accessed from the **Resume Viewing Content** menu.
6. If you have any questions relating to Parental Controls, please refer to the next page.

NOTE: My Selection is a list of titles that you may want to watch at a later time and that you can add to as you browse the list of content by pressing **B**. To view this list, select **My Selection** in the illico On-Demand main menu.

For further information, visit videotron.com/terminal-support.

PARENTAL CONTROLS





Parental Controls is a feature that should have been configured using the Quick-Start Wizard when you set-up your terminal. To configure the Parental Controls settings, please refer to the **Controls and Limits** section on page 37.

If the Parental Controls are active

1. You can disable Controls and Limits by pressing . You will need your Administrator PIN.
2. You will need your Administrator PIN to order content that is blocked by Parental Controls.
3. An Order PIN or Administrator PIN may be used to order content permitted by Parental Controls.

RESUME VIEWING CONTENT

You can resume viewing an on-demand movie that you've paused on the screen of your choice: TV, computer (via the Web), mobile or tablet. Search for content marked by this symbol: .

1. Press .
2. Using , select **Resume Viewing**.
3. Using , select a title that you have already ordered.
4. The time displayed beside each title indicates how much time you have left to watch the ordered content.
5. To exit illico On-Demand, press .

For further information, visit videotron.com/terminal-support.

ILICO ON-DEMAND PREFERENCES

When you browse the illico On-Demand menus, you can access your preferences by pressing **D** or by selecting **Preferences** from the home screen. For further information, please refer to the **Application Preferences** section on page 39.

Select **illico On-Demand preferences** from the main menu and press **OK**. From this menu you can edit your preferences, such as language (**FR** or **EN**) or viewing mode (**HD** or **SD**).

Customizing Display Options

When you consult available content in different sub-menus, you can choose the display that you want (normal, carousel, list or grid) using the **A** button.

View: Normal (default)

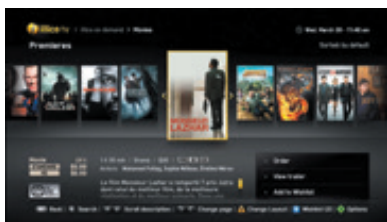

View: Carousel

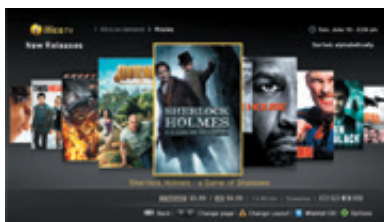

View: List

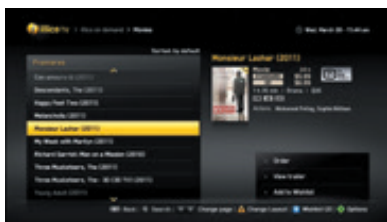

View: Grid

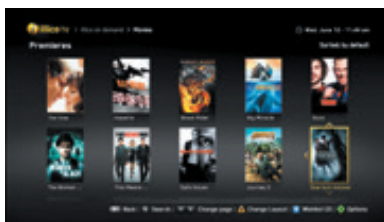

For further information, visit videotron.com/terminal-support.

PAY-PER-VIEW (PPV) SERVICES

Indigo and **Viewers Choice** air commercial-free movies and events, which you can order at any time using the Program Guide. Orders are billed to you the following month.

To order a film or event

1. Press **Guide** to view the Program Guide.
2. Tune in to a Pay-Per-View channel.
 - i. **Indigo**: From channel 300 onwards for standard-definition programming, and from channel 750 onwards for high-definition programming.
 - ii. **Viewers Choice**: From channel 350 onwards for standard-definition programming, and from channel 751 onwards for high-definition programming.
3. Select a time slot and scroll through the movies scheduled to air during this period.
4. Choose a title and press **OK**.
5. Press **Order** to access the content and enter your PIN. If you don't have a PIN, a pop-up window will prompt you to create an Administrator PIN.
6. If the content you selected is unavailable, select **See Other Broadcasts** to view a list of later broadcasts. For more information on Indigo's programming, visit **canalindigo.com** or tune in to channel 300 to watch the trailers.

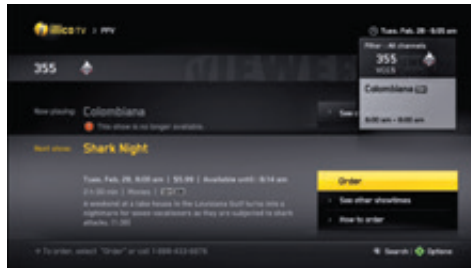

To view orders

1. You can view your orders by tuning in to any Pay-Per-View channel from the Program Guide. Press **D** and select **My PPV Orders**.



NOTE: You can order movies up to four hours in advance, and events up to seven days in advance.

For further information, visit videotron.com/terminal-support.

To cancel an order

You can cancel a Pay-Per-View order free of charge up to two minutes after the start of a movie¹ and up to 15 minutes after the start of an event.² You can cancel your order from **My PPV Orders** screen or by following the instructions below.

1. To cancel **before** the program begins:
 - i. Press .
 - ii. Select the channel and time slot for which you placed your order.
 - iii. Select **Cancel My Order** and enter your PIN in the confirmation window.

2. To cancel **up to 2 minutes after** the program has begun:
 - i. Press .
 - ii. Select the channel and time slot where you placed your order.
 - iii. Press .
 - iv. Select **Cancel My Order** and enter your PIN in the confirmation window.

Parental Controls

Parental Controls operate in conjunction with the Pay-Per-View function. Please refer to the **Controls and Limits** section on page 37.

If the Parental Controls are active:

1. You can disable your Controls and Limits settings by pressing . You will need your Administrator PIN.
2. To order content that is blocked by Parental Controls, you will need your Administrator PIN.
3. To order content allowed by Parental Controls, you can use either your Order PIN or Administrator PIN.

1."Movie" refers to all content, including adult content. 2."Event" refers to special features, such as sporting events and shows.

MULTI-ROOM HD PVR

Take control of your TV experience with the Multi-Room HD PVR. Free yourself from TV schedules without ever missing your favourite TV shows. Record content with the press of a button, and manage your recordings with ease. You can even control live TV, and record two programs at once while you watch a third previously recorded show.

MAIN MENU

The Multi-Room HD PVR's main menu lets you manage content that you've already recorded, and content set to be recorded.

You can view your recordings and programmed recordings, manually record a show, manage your recordings and change your preferences.

Multi-Room HD PVR MAIN MENU

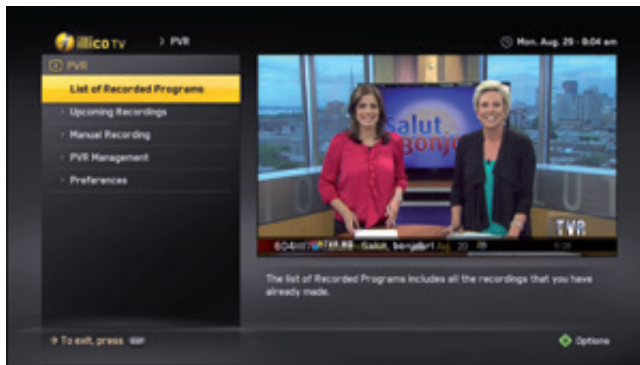

For further information, visit videotron.com/terminal-support.

To access the Multi-Room HD PVR menu

1. Press **MENU** to go to the main menu.
2. Use  to select **Multi-Room HD PVR** and press **OK**.
3. Next, select what you'd like to do.











- **List of recorded shows:** Allows you to view your recordings, play a recording, stop a recording, modify a recording and block a recording that was not filtered by Parental Controls. You can also access this menu by pressing **LIST** on your remote.
- **Upcoming recordings:** Allows you to view a list of your future recordings.
- **Manual recording:** Allows you to manually record within a specified time slot.
- **PVR Management:** Allows you to see the available disk space, and to run the **Free Up Disk Space** function.
- **Preferences:** Allows you to modify your Multi-Room HD PVR's buffer settings and recording storage time.
 - i. A buffer is an area of memory that temporarily stores data. The Multi-Room HD PVR's buffer allows a recording to begin a few minutes (from 1 to 15 minutes) before the start of the program and to end a few minutes (from 1 to 15 minutes) after the program has ended. You'll therefore never miss the recording of a show or movie whose time of broadcast does not coincide with the time indicated in the Program Guide.

LIVE TV CONTROL

TIME SHIFTING ALLOWS YOU TO CONTROL THE SHOW YOU ARE WATCHING AS IT AIRS.

Thanks to its built-in hard drive, the Multi-Room HD PVR stores the images broadcasted on the channel you're watching in a buffer memory. This allows you to pause, rewind or resume viewing a live show.

Useful keys

-  To pause a show for up to an hour. After an hour, you can resume watching a show from where you paused it.
-  To resume viewing.
-  To rewind; press up to four times to increase the rewind speed.
-  To fast-forward; press up to four times to increase the fast-forward speed.
-  To pause/stop a show you're watching.
-  To skip back a few seconds.
-  To skip forward a few seconds.
-  To view a list of your recordings.
-  To resume viewing in real time.
-  To instantly record a show.

HOW TO CONTROL LIVE TV

When you press on one of the buttons mentioned above, the status bar will automatically appear at the bottom of the screen and indicate how far along the show is in terms of its playback and broadcast.

The Multi-Room HD PVR's buffer memory allows you to rewind  a channel up to one hour before you tuned in to it.

Recorded shows stored in the buffer memory will be erased as soon as you change channels or turn off the Multi-Room HD PVR. To save these shows, you have to record and save them by pressing .

For further information, visit videotron.com/terminal-support.



RECORD A TV PROGRAM

Three ways to record a TV program:

1. Record the TV program you are watching.
2. Program the recording of a TV show using the Program Guide.
3. Manually record content within a specified time slot.

Recording the TV program you are watching

If you have been watching the TV program from the beginning, press  at any time during its broadcast, and it will be recorded from the moment you started watching it.



1. Press . The Multi-Room HD PVR will display the choices available to you.
2. If you are watching a series:
 - i. Select **Record this Episode** to record only the episode you are watching.
 - ii. Select **Record Series** to record the TV show you are watching every time it airs, no matter what day or time slot.
3. If you are watching a TV program:
 - i. Select **Record Once** to record only the TV show you are watching.
 - ii. Select **Repeat Recording** to record the TV show you are watching every time it airs.
4. To modify the recording criteria mentioned above, press  and select one of the following options:
 - a. Repeat (or not) the recording.
 - b. Establish the recording frequency.
 - c. Establish how long you'd like the recording(s) to be stored for.
 - d. Select **Record**. Once you have confirmed your changes, the **REC** icon will appear onscreen.

NOTE: To learn how to change the recording frequency, recording options and length of the storage period, refer to the **Manage Your Recordings** section on page 33.

For further information, visit videotron.com/terminal-support.



Programming a recording using the Program Guide

To program the recording of shows you don't want to miss in advance:

1. Press .
2. Select a title that you would like to record and press . The Multi-Room HD PVR will display the options available to you.
3. If you want to record a series:
 - i. Select **Record this Episode** to record only the episode you are watching.
 - ii. Select **Record Series** to record the TV show you are watching every time it airs, no matter what day or time slot.
4. If you want to record a TV show:
 - i. Select **Record Once** to record only the TV show you are watching.
 - ii. Select **Repeat Recording** to record the TV show you are watching every time it airs, if this option is available to you.
5. To modify the recording criteria, press .
6. The title of the programmed recording will be displayed in a red box in the Program Guide.

Manual recording within a specified time slot

To record all TV shows within a specified time slot:

1. Press  to go to the main menu.
2. Use  to select **Multi-Room HD PVR**.
3. Use  to select **Manual Recording**.
4. Fill out the required fields to program the recording.

Modifying an ongoing recording while you watch it

To stop, save or delete a recording that is underway, press  and select the desired option.

Remote Multi-Room HD PVR

You can program your Multi-Room HD PVR to record TV shows via illico.tv or your Videotron mobile phone when you are away from home. You can then watch your favourite shows on your Multi-Room HD PVR when you get back.*

*You must be subscribed to Videotron's digital TV, Internet and mobile telephone services.

MANAGING RECORDING CONFLICTS

The Multi-Room HD PVR allows you to record two TV shows at once while you watch a third, previously-recorded show. In the event that the Multi-Room HD PVR detects three recordings occurring at once, a pop-up window will ask you to resolve the scheduling conflict. In the event that you are not there to resolve it, the problem will be stored and the Multi-Room HD PVR will prioritize the recording of series and movies.



MANAGING YOUR RECORDINGS

This section will show you how to view the content you recorded and how to manage the recording space on your hard drive.

Play recorded content



1. Press **LIST**, select a title and press **OK**.
2. While it is playing, press **PAUSE** to pause or press **REWIND** to go back to the beginning or delete the title.
3. If you have not finished watching the recorded content, return to current programming by pressing **STOP** twice.

NOTE: Suspending a recording allows you to cancel the recording of one episode in a recurring program.

For further information, visit videotron.com/terminal-support.

Blocking recorded content



Turning on Parental Controls will prevent the user from viewing recordings based on age. To block a recording:

1. Press  and select the title you wish to block.
2. Press  and use  to select **Block Manually**.
3. Enter your Administrator PIN.

Getaway function







Bring your Multi-Room HD PVR along with you if you go on a trip so that you can access your recorded TV programs. To connect the terminal to a TV, please refer to the **Connect Your Terminal** section on page 7. Please note that a cable connection is not required.

Deleting recordings

1. Press  and select the title you wish to delete.
2. Use  to select **Delete** and press .

To delete multiple recordings, use the **Free Up Disk Space** function, explained on the following page.

Deleting and modifying upcoming recordings

1. Press  to go to the main menu.
2. Use  to select **Multi-Room HD PVR** and press .
3. Use  to select **Upcoming Recording** and press .
4. Use  to select the recording that you'd like to modify or delete, and then select **Suspend**, **Modify** or **Delete**.

For further information, visit videotron.com/terminal-support.

MANAGING YOUR HARD DISK

The Multi-Room HD PVR has a storage capacity of 500 GB, allowing you to store up to 280 hours of standard-definition content or up to 55 hours of high-definition content. The **PVR Management** function allows you to evaluate the amount of available disk space on your hard drive, while the **Free Up Disk Space** function lets you free up space on your hard drive when you need to.

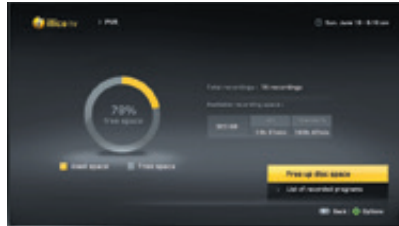

The **Free Up Disk Space** function allows you to manage your recordings and free up space on your hard drive when you need to.

1. Press **MENU** to go to the main menu.
2. Use **Left Arrow** to select **Multi-Room HD PVR** and press **OK**.
3. Use **Left Arrow** to select **PVR Management** and press **OK**.
4. Use **Left Arrow** to select **Free Up Disk Space** and follow the instructions on-screen.

Picture in Picture (PiP)

Picture in Picture (PiP) is an exclusive feature available with the Multi-Room HD PVR that allows you to watch two shows at once.



To activate the PiP feature

1. Press **PIP**.
2. Press **B** to modify the PiP screen display or **C** to change the screen's position.
3. Press **▲** to move content in the main screen to the PiP screen, and vice versa.
4. Press **Left Arrow** to change channels on the main screen, or to go to the Program Guide.
5. Press **PIP** again to close the PiP feature.

For further information, visit videotron.com/terminal-support.



SETTINGS

In this menu, you can access the General Settings, Viewing Controls and Limits, Application Preferences for the TV and terminal, Equipment Settings, and Accessibility features like Closed Captioning.

1. Press  to go to the main menu.
2. Use , to select **Settings** and press .
 - a. General Settings
 - b. Controls and Limits
 - c. Application Preferences
 - d. Equipment Settings (please refer to page 16)
 - e. Accessibility

GENERAL SETTINGS

General Settings allows you to modify your basic preferences, like language (**FR/EN**), your postal code and the widgets' display, as well as launch the Quick-Start Wizard.

1. Press  to go to the main menu.
2. Use  to select **General Settings** and press .

In this menu, you can modify the following settings:

- a. **Language:** Choose the language in which you'd like the illico TV new generation interface to be displayed.
- b. **Postal code:** Enter your postal code to receive geo-located information.
- c. **Display the widget bar when the terminal is turned on:** Choose whether or not you want the widgets to be displayed when the terminal is turned on.
- d. **Quick-Start Wizard:** This is a configuration guide that appears when the terminal is turned on for the first time. It shows you how to configure the device's General Settings, such as language, Administrator PIN and Parental Controls settings.

For further information, visit videotron.com/terminal-support.

CONTROLS AND LIMITS

This menu allows you to modify Parental Controls, restrict access to certain content and create or modify your PINs.

ACCESSING CONTROLS AND LIMITS

It's important to have activated an Administrator PIN using the **Quick-Start Wizard**.

If you haven't done this already, a pop-up window will prompt you to create an Administrator PIN.

Controls and Limits allows you to:

- Manage Parental Controls
- Block content depending on the age of the user (8+, 13+, 16+, 18+)
- Block certain channels
- Block adult content
- Block viewing times
- Protect the settings on your terminal
- Protect the recordings on your Multi-Room HD PVR
- Manage your PINs

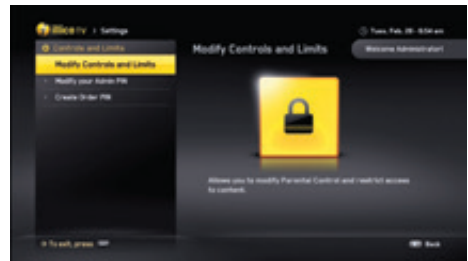

Manage Parental Controls via the main menu

1. Press **MENU** to go to the main menu.
2. Use **OK** to select **Settings**. Next, select **Controls and Limits** and enter your PIN in the window that pops up on-screen.
3. Select **Modify Controls and Limits** by pressing **OK**.
4. Next, select **Enable/Disable Controls and Limits**. You can also choose to suspend Controls and Limits for a limited period of time.
5. Next, select **Enable/Disable Controls and Limits** and choose the appropriate age group (8+, 13+, 16+ or 18+).

NOTE: There is a difference between Parental Controls and Controls and Limits. Parental Controls block content that is inappropriate for viewers under a certain age, while Controls and Limits restrict viewing times, and block channels and users' access to settings.

For further information, visit videotron.com/terminal-support.

Manage Parental Controls settings and Block a Channel

From the **Modify Controls and Limits** menu, you can also:

1. Enable, disable or suspend controls and limits.
2. Enable or disable parental controls according to age.
3. Hide adult content.
4. Select the channels you want to block by using the Restricted Channels feature.
5. Establish for how long the PIN will be able to unblock the channel.
6. Add viewing restrictions based on the time of day.
7. Protect the recordings on your Multi-Room HD PVR.
8. Protect your settings.

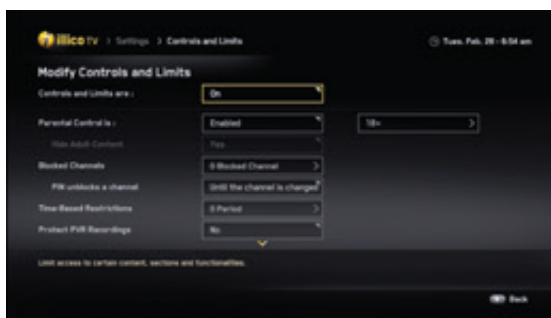



SHORTCUTS: You can **suspend** Parental Controls and **block or unblock** a channel by pressing  during a broadcast, or via the Program Guide.

For further information, visit videotron.com/terminal-support.

APPLICATION PREFERENCES

Configure your Application Preferences (i.e. TV Caller ID, Program Guide, illico On-Demand, Program Guide, Shortcut Menu, etc.).

Accessing the Application Preferences:

1. Press **MENU** to go to the main menu.
2. Use  to select **Settings**.
3. Use  to select **Application Preferences**.

You can then browse through the menu and modify the following applications:

- **Caller ID:** Allows you to see the number of the person calling you, on your TV screen. You must be subscribed to Videotron's Call Display service.
- **Program Guide and TV:** To modify which channel comes on automatically when you turn on your TV, manage your favourite channels, set your display preferences for the Program Guide or set the viewing mode.
- **Viewing Mode:** The terminal allows users to change the viewing mode according to their preferences. An HD TV features a wide screen with a 16:9 aspect ratio, that can display HD content. When an HD TV displays SD content, it's normal that black bars border the left and right sides of the screen.

The viewing modes (Normal, Full or Zoom) allow you to display the content you're watching in proportion to your screen.

4/3



16/9



For further information, visit videotron.com/terminal-support.

Modifying the viewing mode while watching TV

1. Press  up to three times for the picture to change to the desired mode: Normal, Full or Zoom.
- **illico On-Demand:** To modify your preferences, such as the order in which your selections are displayed, the display language (FR/EN) and the content format (HD/SD).
 - **Multi-Room HD PVR:** To modify your Multi-Room HD PVR's buffer settings, and how long your recordings are stored for. For display preferences, refer to the **illico On-Demand Preferences** section on page 25.
 - **Shortcut Menu:** To enable or disable the shortcut menu or delete available options (the Program Guide and illico On-Demand cannot be removed from the Shortcut Menu).

For further information, visit videotron.com/terminal-support.

ACCESSIBILITY

This menu lets you configure your preferences in terms of audio accessibility and Closed Captioning for the hearing-impaired.





Audio accessibility

- **SAP:** Second or third alternative audio track. When a show is broadcasted in SAP mode, you can watch it in the language of your choice.
- **Audio description display (On/Off):** Refers to an additional audio track that allows blind and visually impaired people to hear a description of what is happening on-screen.





Closed Captioning for the hearing impaired

Closed Captioning is the audio portion of a TV program, displayed as subtitles. It features an abridged version of the actors' dialogue as well as important aural indications. Closed Captioning is intended for people who have trouble hearing.

Activating Closed Captioning

1. Press  to go to the main menu.
2. Use  to select **Settings**.
3. Use  to select **Accessibility** and **Closed Captioning**.
4. Use  to select **On/Off** and press .

Modifying audio accessibility and Closed Captioning settings

1. Press  to go to the main menu.
2. Use  to select **Settings** and press .
3. Use  to select **Accessibility** and press 
 - i. **Audio Accessibility:** Allows you to change the audio track (SAP mode).
 - ii. **Closed Captioning:** Allows you to modify Closed Captioning options.

Configuring Closed Caption settings (Closed Captioning must be active)

1. Using the  button, choose display options either by **Show** or by **User**. Once the user has configured the display, you can modify the characters that appear onscreen.

Digital Closed Captioning mode

- **Digital Source 1** is the standard Closed Captioning channel.
- **Digital Source 2** is the recommended option in terms of language selection.
- **Digital Source 3 to 6** are options to come.

Closed Captioning channels: **CC1, CC2, CC3, CC4, CC5, CC6.**

For further information, visit videotron.com/terminal-support.

FREQUENTLY ASKED QUESTIONS

NOTICE: The first step in resolving problems related to the illico TV service is to reboot the terminal. Rest assured—your terminal settings, as well as the recordings on your Multi-Room HD PVR will remain intact. To reboot the terminal, unplug the power supply cord, then plug it back in again a few seconds later. Wait a few minutes before turning the terminal back on. If the problem persists, please contact Technical Support at 1-877-380-2611.

Where can I learn more about illico TV's Program Guide, menus and applications?

You can access our Help Portal from the main menu, as well as at support.videotron.com. This is where you'll find instructional videos and answers to the most frequently asked questions. To access the Help Portal via the illico TV main menu, press **MENU** on your remote control and select **Help**.

Can I program my remote control to my TV?

Yes. Please follow the programming procedure on page 12.

I can't control the terminal's volume with the remote control. Is this normal?

In order to provide you with the highest level of sound quality, the volume controls on the terminal are disabled when the latter is connected with an HDMI cable. If this is the case, you will only be able to control the volume on your TV. You will have to program your remote control to your TV by following the instructions on page 12.

I programmed my remote control, and now the sound isn't working. What should I do?

You may have activated the terminal's "Mute" function while programming the remote control by pressing OK/SELECT and MUTE. If this is the case, press the VOL+ button on your terminal. This will disable the "Mute" function, and bring the sound back.

Why is the sound on my TV so low?

Your terminal's **Volume** function controls the strength of the audio signal emitted by the terminal. When the terminal's volume is low, the signal it sends to the TV is equally low. To prevent this, we suggest that you program your remote control to your TV by following the instructions on page 12, and then program the terminal so that you can only control the volume on your TV. To do this, please refer to the **Equipment Settings** section on page 16.

My terminal is not working, or my TV screen is black, blue, blurry or snowy. What do I do?

Make sure the terminal is turned on and that you followed the steps for activating (on page 4) and connecting (on page 7) the terminal. Because your TV has multiple inputs, it's important to let your TV know the one you're using. Set your TV to the right input using the remote control it came with, i.e. by setting it to either Input 1, 2 or 3; Component 1, 2 or 3; or HDMI 1, 2 or 3.

For further information, visit videotron.com/terminal-support.

The sound cuts out or the picture breaks up when I watch TV. What do I do?

Reboot the terminal by unplugging the power supply cord and plugging it back in. If the problem persists, restart the terminal as indicated above, or contact Technical Support at 1-877-380-2611.

When I plug in my terminal with an HDMI cable, the picture breaks or an error message appears onscreen. What do I do?

Once you've made sure that the HDMI cable is properly plugged into the terminal, reboot the terminal by unplugging the power supply cord and plugging it back in. If the problem persists, it may be that your TV is not compatible with the terminal's HDMI port. Instead, proceed with the alternative connection by using a component cable. Seeing as the terminal does not come with a component cable, please contact your retailer or call Technical Support at 1-877-380-2611.

Is it normal that broadcasts on certain channels don't fill the screen?

Yes. The only channels that broadcast full screen are HD channels (channels after channel 600). Channels where the picture does not fill the screen are standard-definition channels. However, some shows airing on HD channels are broadcast in standard definition.

How can I switch to full screen mode when I'm watching a channel that's broadcast in standard definition?

The # button on your remote control allows you to stretch the picture or to zoom in and get rid of the black bars that border the left and right of the screen when you're watching a channel in standard definition. Press on # until you obtain the desired zoom mode: Normal, Large or Zoom.

After activating my terminal, is it normal that I can access channels that are not included in my TV package?

Yes. Once you have activated your terminal, you'll be able to access the channels included in your TV package on the business day following the activation date. As a result, you'll have free, temporary access to several channels that aren't necessarily part of your TV package.

CUSTOMER SERVICE AND TECHNICAL SUPPORT

CUSTOMER SERVICE

For further information, we invite you to visit the illico TV Help Portal, to check out instructional videos at videotron.com/terminal-support or to contact Customer Service. You can reach a representative Monday–Friday from 7:30 a.m. to 10 p.m., Saturdays from 8 a.m. to 8 p.m. and Sundays from 9 a.m. to 8 p.m.

Montréal: 514-281-1711

Quebec City: 418-847-4410

Saguenay: 418-545-1114

Outaouais Region: 819-771-7715

Elsewhere in Québec: 1-888-433-6876

TECHNICAL SUPPORT

For problems of a technical nature, we invite you to contact Technical Support. You can reach a representative 24 hours a day, 7 days a week.

Montréal: 514-841-2611

Quebec City: 418-842-2611

Saguenay: 418-543-4611

Outaouais Region: 819-771-2611

Elsewhere in Québec: 1-877-380-2611

For further information, visit videotron.com/terminal-support.

LIST OF REMOTE CONTROL PROGRAMMING CODES

TV Codes

3M - 10737, 11616, 11655	Brockwood - 10019	Durabrand - 10463, 10180,	Goodmans - 10360
A-Mark - 10003	Broksonic - 10236, 10463,	10178, 10171 11034,	GPX - 10360
Abex - 10032	10003, 10426 11905,	10003, 11665	Gradiente - 10392
Accurian - 11803	11911, 11929, 11935	Dwin - 10747	Grumpy - 10180, 10179
Action - 10873	Byd:sign - 11309	Dynex - 12049, 11463	H & B - 11366
Admiral - 10093, 10463,	C&M - 10700	Eiki - 10735	Haier - 11034, 10768,
10179	Cadia - 11283	Electroband - 10000, 10185	11009, 11570, 11748
Advent - 10761, 10783,	Candle - 10030, 10046,	Electrograph - 11755,	Hallmark - 10178
10815, 10817 10842,	10056, 10186	11623	Hanns.G - 11783
11933	Carnivale - 10030	Electrohome - 10463,	Hannspree - 11348, 11745,
Adventura - 10046	Carver - 10054, 10170	10381, 10409, 11570	11783
Aftron - 10891	Casio - 10611, 11205	11670, 11672	Harley Davidson - 10043,
Aiko - 10092	CCE - 10217, 10329	Element - 11687, 12183	10179, 11904
Aiwa - 10032, 10701,	Celebrity - 10000	Emerson - 11864, 11394,	Harman/Kardon - 10054
11362, 11955	Changhong - 10765	10154, 10451, 10236,	Harvard - 10180, 10068
Akai - 10812, 11675, 10702,	Cinego - 11986	10462, 10180, 10178,	Hewlett Packard - 11494,
10030, 10098, 10672,	Citizen - 10060, 10030,	10171, 11661, 11905,	11088, 11089, 11101
11207, 11385, 11676,	10092, 10046 10056,	11909, 11911, 11913,	Hisense - 10748, 11314,
11686, 11688, 11689,	10186, 10280, 10561	11929, 11944, 11963,	11660, 12089
11690, 11692, 11935,	11669, 11671, 11672,	12167, 10282, 10280,	Hitachi - 10279, 10227,
12232	11935	10183, 10182, 10181,	10217, 10173, 10151,
Alaron - 10179, 10183,	Claritone - 10185	10179, 10177, 10158,	10097, 10096, 10095,
10216	Clarion - 10180	10039, 10038, 10019,	10056, 10043, 10038,
Albatron - 10700, 10843	Classic - 11984	10002	10036, 10032, 10016
Ambassador - 10177	Coby - 11538, 12017,	Emprex - 11422, 11765	HP - 11494, 11088, 11089,
America Action - 10180	12306, 12314 12315,	Encross - 10876, 11474	11101
Anam - 10180, 10004,	12326, 12338, 12340,	Envision - 10030, 10813,	Hyundai - 10849, 11219,
10009, 10008	12344, 12345, 12347,	11365, 12014, 12087	11294
Anam National - 10161	12348 12351, 12560	Epson - 11122, 11290	I-Inc - 11746
AOC - 10030, 10003, 10019,	Commercial Solut. - 10047	Erae - 11222	iLo - 11394, 11286, 11603,
10052, 10185, 11089,	Compaq - 10749	ESA - 10171, 11944, 11963	11665, 11684, 11990
11365, 11589, 11590,	Concerto - 10056	Fisher - 10154, 10159	Infinity - 10054
12014, 12087, 12402,	Contec - 10180	Fujitsu - 10179, 10186,	Initial - 11603, 11990
12479	Craig - 10180	12008	Insighnia - 12049, 11423,
Aomni - 11623	Crosley - 10000, 10054	Funai - 10000, 10180,	10463, 10171, 11204,
Apex Digital - 10748, 10879,	Crown - 10180, 10039	10171, 10179, 11904,	11326, 11385, 11517,
10765, 10890 11217,	CTX - 10700	11963	11660, 11892, 11963,
11991, 12397	Curtis - 11200, 11326,	Futuretech - 10180	12002, 12417
Archer - 10003	12352, 12466	Gateway - 11755, 11001,	Inteq - 10017
Astar - 11531, 11738	CXC - 10180	11756	IRIS - 12189
Audiovox - 10451, 10180,	Cyberhome - 10794	GE - 10047, 10051,	IX - 10877
10092, 12513, 11952,	Cyttron - 11326	10451, 10178, 10021,	Janeil - 10046
11951, 11937, 11868,	Daewood - 10145, 10451,	10027, 10029, 10055,	JBL - 10054
11803, 11769, 11766,	10092, 11661 10019,	10135, 10279,	JCB - 10000
11284, 10875, 10846,	10066, 10067, 10091	10282, 10747, 11907,	JCM - 12189, 12256
10802, 10713, 10623,	10672, 11909	11919, 11922, 12359	Jensen - 10761, 10050,
10003, 12413	Daytron - 10019	GFM - 10171, 11665, 11963,	10817, 11299, 11326,
Aurora Systems - 10801	Dell - 11264, 11080, 11178	12167	11933
Aventura - 10171	Delta - 11369	Gibraltar - 10017, 10030,	JVC - 10463, 10053, 10036,
Axion - 10171	Denon - 10145, 10511	10019	10069, 10160, 10169,
Belcor - 10019	Diamond Vision - 11996	Go Video - 10886, 11823,	10182, 10731
Bell & Howell - 10154,	Digistar - 11565	11831	Kamp - 10216
10016	Digital Lifestyles - 11765,	GoldStar - 10178, 10030,	Kawasho - 10158, 10216,
BenQ - 11032, 11315	11822	10002, 10019, 11032,	13008
Bradford - 10180	Disney - 11665, 12152	10039, 10056, 10409,	Kaypani - 10052
Brilliant - 11007	Dumont - 10017, 10019	11926	KDS - 11687

For further information, visit videotron.com/terminal-support.

KEC - 10180
 Kenwood - 10030, 10019
 KLH - 10765, 10767
 Kloss - 10024, 10046
 Knoll Systems - 10781
 KMDS - 12278
 Konka - 10632, 10638,
 10707, 11385, 11831,
 11939
 Kost - 11262, 11483
 Kreisen - 10876, 11474
 KTV - 10180, 10030, 10039,
 10183, 10185, 10217,
 10280
 LG - 11423, 10017, 11265,
 10178, 10442, 10700,
 10856, 11178, 11530,
 11637, 11934
 LiteOn - 10088
 Lloyd's - 11904
 Loewe - 10136
 Logik - 10016
 Luce - 10837, 11031
 Luxman - 10056
 LXI - 10047, 10054, 10154,
 10156, 10178, 10148,
 10747
 MAG - 11678
 Magnasonic - 11713, 11913
 Magnavox - 11454, 11866,
 11755, 10054, 10051,
 10030, 10171, 10706,
 11944, 11963, 11931,
 11913, 11904, 11990,
 12372, 11525, 12597,
 11365, 11198, 10802,
 10386, 10230, 10187,
 10186, 10179, 10096,
 10036, 10028, 10024,
 10020
 Magnin - 11907
 Majestic - 10016
 Marantz - 11454, 10054,
 10030, 10704, 11714,
 12447
 Matsushita - 10250
 Maxent - 11755, 11597,
 11714, 11757
 MB Quart - 11868
 Megatron - 10178, 10145,
 10003
 Memorex - 10154, 10463,
 10150, 10178, 10016,
 10179, 10877, 11570,
 11665, 11670, 11892,
 11911, 11920, 11924,
 11926
 MGA - 10150, 10178,
 10030, 10019, 10155,
 11907
 Micro - 11436
 Midland - 10047, 10017,
 10051, 10032, 10039,
 10135, 10747
 Mintek - 11603, 11990
 Minutz - 10021
 Mitsubishi - 11250, 10093,
 10150, 10178, 10014,
 10019, 10036, 10098,
 10155, 10331, 10592,
 11797
 Monivision - 10700, 10843
 Motorola - 10093
 MTC - 10060, 10030,
 10019, 10056, 10091,
 10185, 10216
 Multitech - 10180, 10217
 NAD - 10156, 10178, 10056
 Nakamichi - 11493
 Naxa - 11998
 NEC - 10030, 10019, 10036,
 10056, 10170, 10704,
 11797, 12026
 NetTV - 11755
 Nexus Electronics - 12183
 Nikko - 10178, 10030,
 10092
 Niko - 11581
 Noblex - 10430
 Norcent - 10748, 10824,
 11089, 11365, 11590,
 11591
 Norwood Micro - 11286,
 11296
 Noshi - 10018
 NTC - 10092
 NuVision - 11657
 Olevia - 11610, 11144,
 11240
 Onwa - 10180
 Optimus - 10250, 10154,
 10166, 11913, 11924
 Optoma - 10887, 11348
 Optonica - 10093, 10165
 Orion - 10236, 10463,
 11463, 10179, 11905,
 11911, 11929
 Panasonic - 11480, 10250,
 11457, 10051, 10161,
 10162, 10226, 11291,
 11919, 11924, 11947,
 11969
 Park - 12104
 PDI - 11474
 Petters - 11523
 Philco - 11394, 10054,
 10030, 10171, 10019,
 10020, 10024, 10028,
 10096, 10179, 10187,
 10381, 11665, 11963
 Philips - 11454, 11394,
 11866, 10054, 10690,
 11483, 11744, 12372,
 12597
 Pilot - 10030, 10019, 10039
 Pioneer - 11457, 10166,
 10038, 10172
 Planar - 11496
 Polaroid - 11523, 10765,
 12120, 12117, 12063,
 12002, 11991, 11962,
 11769, 11767, 11766,
 11762, 11687, 11565,
 11538, 11385, 11341,
 11328, 11327, 11326,
 11316, 11314, 11286,
 11276, 11262, 10865,
 11314, 11286, 11276,
 11262, 10865, 11385
 Portland - 10451, 10092,
 11661, 10019, 10039
 Prism - 10051
 Proscan - 10047, 10030,
 10466, 10747, 11922,
 12147, 12183, 12256
 Proton - 10178, 10003,
 10031, 10052, 10466
 Protron - 11320, 11323
 Proview - 11687
 Pulsar - 10017, 10019
 Pvision - 11222
 Pyle - 11200
 Quasar - 10250, 10051,
 10165, 10219, 11291,
 11919, 11924, 11969
 RCA - 12434, 10047, 10051,
 10093, 11661, 12932,
 12746, 12002, 11958,
 11953, 11922, 11919,
 11907, 10747, 10278,
 10254, 10135, 10090,
 10038, 10029, 10019,
 10018
 Realistic - 10154, 10180,
 10178, 10030, 10019,
 10032, 10039, 10056,
 10165
 RevolutionHD - 11623
 Rhapsody - 10183, 10185,
 10216
 Runco - 10017, 10030,
 10612
 Sampo - 11755, 10030,
 10032, 10039, 10052,
 10100, 10110, 11597
 Samsung - 12051, 10060,
 10702, 10178, 10030,
 11959, 11060, 10814,
 10766, 10587, 10482,
 10427, 10329, 10217,
 10056, 10039, 10032,
 10019
 Samsux - 10039
 Sansui - 10463, 10171,
 10165, 10173, 11670,
 11892, 11904, 11911,
 11929, 11935
 Sanyo - 10054, 10154,
 10036, 10088, 10107,
 10146, 10159, 10232,
 10484, 10798, 11907
 Sceptre - 10878, 11217,
 11360, 11599, 12337
 Scimitus - 10019
 Scotch - 10178
 Scott - 10236, 10180,
 10178, 10019, 10179,
 10309, 11711
 Sharp - 10093, 10039,
 10153, 10157, 10165,
 10281, 10386, 10491
 Sharper Image - 11950
 Sheng Chia - 10093
 Shogun - 10019
 Signature - 10054, 10016
 Signet - 10800, 10844,
 11262
 Simpson - 10186, 10187
 Skyworth - 11799
 Solarism - 11220
 Sole - 11031, 11366, 11377,
 11483, 11530, 11623,
 12076
 Sony - 10810, 10000,
 10011, 10080, 11400,
 11685, 11904, 11925
 Soundesig - 10180, 10178,
 10179, 10186
 Sova - 11320, 11952
 Soyo - 11746, 11826,
 11828, 11830, 11831
 Spectron - 10003, 10137
 Spectronix - 11687
 Squareview - 10171
 SSS - 10180, 10019
 Starlite - 10180
 Studio Experience - 10843
 SunBrite - 11420, 11435,
 12337
 Superscan - 10093, 10864,
 10194
 Supre-Macy - 10046
 Supreme - 10000
 SVA - 10748, 10587, 10768,
 10865, 10871, 10872,
 11963
 Sylvania - 11864, 11394,
 10054, 10030, 10171,
 11963, 11944, 11931,
 11913, 11665, 11314,
 10587, 10381, 10187,
 10096, 10065, 10028,
 10024, 10020
 Symphonic - 10180, 10171,
 11904, 11913
 Syntax - 11610, 11144,
 11240
 Tandy - 10093, 10218
 Tatum - 10003, 11101,
 11286, 11287, 11288,
 11361, 11503, 11756
 Technics - 10250, 10051
 Technol Ace - 10179
 Techview - 10847, 12004
 Techwood - 10051, 10003,
 10056
 Teknika - 10054, 10180,
 10150, 10060, 10092,
 10016, 10019, 10039,
 10056, 10179, 10186,
 10312
 Telefonken - 10702, 10056
 Tera - 10031
 Thomas - 11904
 Thomson - 10209, 10625
 TMK - 10178, 10056, 10177
 TNCi - 10017
 Toshiba - 10156, 10154,
 11265, 10060, 10003,
 10036, 10149, 11343,
 11369, 11935, 11945,
 11959, 12006
 Tosonic - 10185
 Television - 10039
 Trical - 10157
 TruTech - 11665, 11723, 12066

For further information, visit videotron.com/terminal-support.

TVS - 10463	11330, 11365, 11578,	White Westinghouse -
Ultra - 10391, 11323	11627, 11742, 12014,	10463, 11661, 11909
Universal - 10027	12087	WinBook - 11381, 11503
US Logic - 11286	Viking - 10046, 10312	Wyse - 11365
Vector Research - 10030	Viore - 11207, 11684,	Yamaha - 10030, 10019,
Venturer - 11865	11811, 12104, 12087	10797
VEOS - 11007	Visart - 11336	Zenith - 11423, 10000,
Victor - 10053	Vizio - 11758, 10864,	10047, 10017, 10463,
Video Concepts - 10098	10885, 11756	11265, 10178, 10030,
Vidikron - 10054	Waycon - 10156	10145, 10092, 11661,
Vidtech - 10178, 10019,	Westinghouse - 10451,	10160, 11365, 10016,
10036	10885, 10889, 10890,	11904, 11909, 11911,
Viewsonic - 11755, 10797,	11217, 11282, 11577,	11929
10857, 10864, 10885,	12293	Zonda - 10003

Audio Amplifier Codes

Accuphase - 30382	32706	Marantz - 30892, 30321,	Polk Audio - 30892, 30269,
Acurus - 30765	Elan - 30647	30269, 31892, 32138	32242, 32243
Adcom - 31100	Emotiva - 31908	Mark Levinson - 31438,	Primare - 31851, 31853,
Aiwa - 30406	Forte - 30606	32405	32008
Altec Lansing - 31742	Gateway - 31621	Macintosh - 30251	RCA - 30300
Anthem - 32220	GE - 30078	Mondial - 30765	Regent - 31568
Aragon - 39765	Goldstar - 30031	NAD - 31767, 31995, 32879	Russound - 31873
Arcam - 31881	Halcro - 31934, 32198	Naim - 30552	Sansui - 30321
Bladelius - 31994	Harman/Kardon - 30892,	Nakamichi - 30321	Sonance - 32433
Bose - 30674	30106	NAT - 32562	Sony - 30689, 30220,
Breath - Audio 31963	JVC - 30331	NEC - 30264	30815, 31769
Bryston - 32359	Kenwood - 30356	Nuvo - 31963	Soundesign - 30078, 30211
Cal. Audio Labs - 31098	Krell - 31837, 31926, 32463	Optimus - 30395, 30300	Technics - 30308, 30521
Cambridge Audio - 31982	Left Coast - 31592	Panasonic - 30308, 30521	Thule Audio - 31851, 32169
Carver - 30269	Lenox - 31561	Parasound - 30246, 31934,	Velodyne - 31941
Cinema Sound - 30160	Lexicon - 31145, 31802	32245	Victor - 30331
Classe - 31461, 31462,	Linn - 30269	Pass Labs - 30269	Yamaha - 30354, 30133,
31915, 32854	Logitech - 31408	Philips - 30892, 30269	30143, 30504, 32592
Curtis Mathes - 30300	Luxman - 30165	Pioneer - 30013, 30300,	ZVOX - 32333
Denon - 30160, 32134,	Magnavox - 30269	31932	

Audio-Video Amplifier Codes

ADA - 31946	Go Video - 31532	Nakamichi - 31313, 30097,	Sharper Image - 31385,
ADC - 30531	GPX - 32604	31555, 31642	31409, 31411, 31416,
Adcom - 30616, 32294	Harman/Kardon - 30110,	NexxTech - 31751	31545, 31546, 31549,
Aiwa - 31405, 31388, 31641	30189, 31306, 32443	Niro - 31634	31723
Akai - 30224, 31512	Hitachi - 31801	Norcent - 31389, 31751	Sherwood - 30062, 30491,
Alco - 31390	Initial - 31426	Nova - 31389	30502, 31077, 31423,
Altec Lansing - 32597	Insignia - 31030, 31077,	Nuvo - 32509	31517, 31567, 31653,
AMC - 31077	31652, 31751, 31893,	Onkyo - 31805, 30135,	31905, 31913, 31953,
Amphion Media - 31563,	32126, 32169, 32175,	31298, 31531, 32451	31966, 31971, 32169,
31615	32472, 32929, 32966	Optimus - 31023, 30042,	32264
AMW - 31563, 31615	Integra - 31805, 30135,	30186, 30531, 30670,	Sherwood Newcastle -
Anam - 31609, 31074	31298	30797, 31074	31567, 31913, 32169
Anthem - 31231	iSymphony - 32018, 32258,	Oritron - 31497	Sonic Blue - 31383, 31532,
Apex Digital - 31257, 31430,	32442	Panasonic - 32967, 31308,	31869
31774	Jamo - 31564	31518, 30039, 30367,	Sonic Frontiers - 31231
Arcam - 31189, 31984,	JBL - 30110, 31306	31316, 31509, 31548,	Sony - 31759, 31622,
32002, 32256	Jensen - 30797	31633, 31676	30158, 31131, 31382,
Audiologic - 31646	JVC - 30074, 30531, 31374,	Parasound - 31839, 31907,	31503, 31558, 31658,
Audiotronic - 31189	31495, 31676	32246	31722, 31758, 32216,
Audiovox - 31390	KEF - 31718	Philips - 31189, 31269,	32475
B & K - 30701, 30820,	Kenwood - 31313, 30042,	32311, 30189, 30391,	Soundesign - 30670
30840, 31992	30077, 30186	30891, 31089, 31266	Spherex - 31927
Bose - 31229, 30639,	KLH - 31390, 31412, 31428	Pioneer - 31023, 30176,	Stereophonics - 31023
31253, 31841, 31933	Klipsch - 31443	30531, 30630, 31384,	Sunfire - 31313, 31931,
Cambridge Sound - 31370,	Koss - 31497	31459, 31831, 31935	32668
31477, 31624, 32297	Lasonic - 31798	Polaroid - 31508, 32150	Teac - 30163, 30463,
Capetronic - 30531	Lenox - 31437	Polk Audio - 31289, 32270	31074, 31226, 31390,
Carver - 31189, 30008,	Lexicon - 31076	Proscan - 31254	31528, 32261, 32363
30042, 30360	LG - 31293, 31524, 32197,	Quasar - 30039	Technics - 31308, 31518,
Casio - 30195	32676	RCA - 31023, 31609, 31254,	30039, 30208, 30309,
Clarinette - 30195	Liquid Video - 31497	30346, 30531, 31074,	31633
Classic - 31352	Lloyd's - 30195	31390, 31459, 31511,	Thomson - 31910
Coby - 31389, 31513, 32127	Magnavox - 31189, 31269,	32041, 32611	Thorens - 31189
Criterion - 31420	30189, 30195, 30391,	Realistic - 30195	Venturer - 31390
Curtis - 31389, 31596	30531, 31089, 31514	Regent - 31437	Victor - 30074
Daewoo - 31250	Marantz - 31189, 31269,	Rio - 31869	Vivid - 31635
Denon - 32857, 31360,	30039, 30189, 31289	Saba - 31519	Vizio - 31517
30176, 30273, 30771,	McIntosh - 31289	Samsung - 31295, 31868	Yamaha - 32061, 30176,
32230, 32247, 32255,	MCS - 30039, 30346	Sansui - 30346	30186, 30376, 31176,
32279, 32414	Micromega - 31189	Sanyo - 30219, 30360,	31276, 31331, 31375,
Emerson - 32026	Mitsubishi - 31393, 31957	30801, 31251, 31469,	31476, 32455, 32467,
Fisher - 30042, 31409,	Modulaire - 30195	31801	2471
31801	Myryad - 31189, 31901	Sharp - 30186, 31952	Yorx - 30195
Garrard - 30424, 30463	NAD - 30320, 31889, 31989,		Zenith - 30857, 31293,
Gateway - 31517, 31567	32309		31524, 31652
GE - 31379			

For further information, visit videotron.com/terminal-support.

SECURITY

Please read these rules for safe operation before connecting your terminal.

POSITIONING AND VENTILATION

The terminal has openings for ventilation that protect it from overheating.

- Avoid obstructing these openings and do not place other equipment, including televisions, lamps, books or any other objects, on the terminal. Do not place it in an enclosure such as a bookcase or equipment rack, unless suitable ventilation is provided.
- Do not place the terminal on a bed, sofa, rug or similar surface, or close to a radiator or heat register.
- Lay the terminal on a stable surface that's able to support its size and weight.

ACCESSORIES AND CLEANING

Only use Videotron-recommended accessories. Do not open the cover of the terminal.

Unplug the terminal and clean it with a damp cloth. Do not use a liquid or aerosol cleaner, or a magnetic/static cleaning device.

OBJECT AND LIQUID ENTRY

Do not expose the terminal to humidity, or spill liquids on or near the device.

Do not place the terminal on a wet surface. Never push objects into the terminal's openings, as they may touch dangerous voltage points or cause short-circuits that could result in a fire or electric shock.

POWER SOURCES

A label on the terminal indicates the correct power source for the terminal. Only plug the terminal into an outlet that has the same voltage and frequency as those indicated on the label.

Do not overload electrical outlets or extension cords, as this can result in a fire or electric shock.

POWER SUPPLY CORD PROTECTION

Arrange all power supply cords so that people cannot step on them. Do not place objects on or against the cords, as this may damage them. Pay particular attention to cords that exit the terminal and those that are plugged in to other equipment or an electrical outlet.

GROUNDING

The terminal has a two-prong plug. Properly ground the unit by inserting the plug into a grounded electrical two-socket outlet. If the plug is polarized, it will have one wide prong and one narrow prong. This plug will fit into an outlet only one way.

Caution! To prevent electric shock, insert the plug's wide prong into the outlet's wide slot. If you are unable to insert this plug fully into the outlet, contact an electrician to replace your obsolete outlet.

SERVICING

The terminal comes with a basic 36-month warranty. If you open the cover, your warranty will be void. Refer all servicing to a certified Videotron technician. Service should be referred to a certified Videotron technician when any of the following occurs:

- There is damage to the power supply cord or plug.
- Liquid enters the unit, or there is exposure to rain or water.
- A heavy object falls on the unit or you drop the unit or damage the cabinet.
- It does not operate properly (the instructions describe the proper operation).
- The unit exhibits a distinct change in performance.

EXTENDED WARRANTY

To give you greater peace of mind, Videotron gives you the opportunity to extend your warranty for another two years. To benefit from the extended warranty, you must purchase it in the 30 days following the service activation date. The terminal will then be covered for a total of five years after the activation date.

For further information, visit videotron.com/terminal-support.